



**geo-FENNEL FTS 300
TOTALSTATION**



User Manual

**Totalstation
FTS 300**

FOREWORD

Thank you for purchasing the geo-FENNEL Electronic Total Station, FTS 300 series. For the best performance of the instruments, please carefully read these instructions and keep them in a convenient location for future reference.

General Handling Precautions

Before starting work or operation, be sure to check that the instrument is functioning correctly with normal performance.

Do not submerge the instrument into water.

The instrument can not be submerged underwater.

The instrument is designed based on the International IP54, therefore it is protected from the normal rainfall.

Setting the instrument on a tripod

When mounting the instrument on a tripod, use a wooden tripod when possible. The vibrations that may occur when using a metallic tripod can effect the measuring precision.

Installing the tribrach

If the tribrach is installed incorrectly, the the measuring precision could be effected.

Occasionally check the adjusting screws on the tribrach. Make sure the base fixing lever is locked and the base fixing screws are tightened.

Guarding the instrument against shocks

When transporting the instrument, provide some protection to minimize risk of shocks. Heavy shocks may cause the measurement to be faulty.

Carrying the instrument

Always carry the instrument by its handgrip.

Exposing the instrument to extreme heat

Do not leave the instrument in extreme heat for longer than necessary. It could adversely affect its performance.

Sudden changes of temperature

Any sudden change of temperature to the instrument or prism may result in a reduction of measuring distance range, i.e when taking the instrument out from a heated vehicle. Let instrument acclimate itself to ambient temperature.

Battery level check

Confirm battery level remaining before operating.

Taking the battery out

It is recommended not to take the battery or external battery out during the power is on. All the data stored is possible gone at that time. So please do your assembling or taking the battery out after the power is off.

Do not hold the lower part of display unit

When you take out the instrument from a carrying case, or keep into the case, please hold the hand grip and base of the instrument. Please do not hold the lower part of the display unit.

External power source

Use only recommended batteries or external power source. Use of batteries or an external power source not recommended by us may result in equipment failure. (For further information see the chapter 'BATTERY SYSTEM.')

Display for Safe Use

In order to encourage the safe use of products and prevent any danger to the operator and others or damage to properties, important warnings are put on the products and inserted in the instruction manuals.

We suggest that everyone understand the meaning of the following displays and icons before reading the "Safety Cautions" and text.

WARNING

Ignoring or disregard of this display may lead to the danger of death or serious injury.

CAUTION

Ignoring or disregard of this display may lead to personal injury or physical damage.

- Injury refers to hurt, burn, electric shock, etc.
- Physical damage refers to extensive damage to buildings or equipment and furniture.

Safety Cautions

WARNING

- **There is a risk of fire, electric shock or physical harm if you attempt to disassemble or repair the instrument yourself.**

This is only to be carried out by geo-FENNEL or an authorized dealer, only!

- **Cause eye injury or blindness.**

Do not look at the sun through a telescope.

- **Risk of fire or electric shock.**

Do not use damaged power cable, plug and socket.

- **High temperature may cause fire.**

Do not cover the charger while it is charging.

- Risk of fire or electric shock.

Do not use damaged power cable, plug and socket.

- **Risk of fire or electric shock.**

Do not use a wet battery or charger.

- **May ignite explosively.**

Never use an instrument near flammable gas, liquid matter, and do not use in a coal mine.

- **Battery can cause explosion or injury.**

Do not dispose in fire or heat.

- **Risk of fire or electric shock.**

Do not use any power voltage except the one given on manufacturers instructions.

- **Battery can cause outbreak of fire.**

Do not use any other type of charger other than the one specified.

- **Risk of fire or electric shock.**

Do not use an AC cable incompatible with the power supply voltage in use.

- **The short circuit of a battery can cause a fire.**

Do not short circuit battery when storing it.

 **CAUTION**

-
- **Do not connect or disconnect equipment with wet hands, you are at risk of electric shocks if you do!**
 - **Risk of injury by overturn the carrying case.**
Do not stand or sit on the carrying cases.
 - **Please note that the tips of tripod can be hazardous, be aware of this when setting up or carrying the tripod.**
 - **Risk of injury by falling down the instrument or case.**
Do not use a carrying case with a damaged which belts, grips or latches.
 - **Do not allow skin or clothing to come into contact with acid from the batteries, if this does occur then wash off with copious amounts of water and seek medical advice.**
 - **A plumb bob can cause an injury to a person if used incorrectly.**
 - **It could be dangerous if the instrument falls over, please ensure you attach a handle battery to the instrument securely.**
 - **Ensure that you mount the Tribach correctly, failing to do so may result in injury if the tribrach were to fall over.**
 - **It could be dangerous if the instrument falls over, please check that you fix the instrument to the tripod correctly.**
 - **Risk of injury by falling down a tripod and an instrument.**
Always check that the screws of tripod are tightened.
 - **The battery is to be disposed of safely.**
 - **The appliance is not intended for use by young children or infirm persons without supervision. Young children should be supervised to ensure that they do not play with the appliance.**

- **User**

- **Exceptions from Responsibility**

- 1)The user of this product is expected to follow all operating instructions and make periodic checks of the product's performance.
- 2)The manufacturer, or its representatives, assumes no responsibility for results of a faulty or intentional usage or misuse including any direct, indirect, consequential damage, and loss of profits.
- 3)The manufacturer, or its representatives, assumes no responsibility for consequential damage, and loss of profits by any disaster, (an earthquake, storms, floods etc.).
- 4)The manufacturer, or its representatives, assumes no responsibility for any damage, and loss of profits due to a change of data, loss of data, an interruption of business etc., caused by using the product or an unusable product.
- 5)The manufacturer, or its representatives, assumes no responsibility for any damage, and loss of profits caused by usage except for explained in the user manual.
- 6)The manufacturer, or its representatives, assumes no responsibility for damage caused by wrong movement, or action due to connecting with other products.

Contents

FOREWORD	1
General Handling Precautions	1
Display for Safe Use	2
Safety Cautions	2
User	3
Exceptions from Responsibility	3
Content	4

1. NOMENCLATURE AND FUNCTIONS	7
Nomenclature	7
Display	9
Operating Key	10
Function Key (Soft Key)	11
Star key mode	12
Serial signal RS232-C connector	13

2. PREPARATION FOR MEASUREMENT	14
Setting Instrument Up For Measurement	14
Power Switch Key ON	15
Battery Power Remaining Display	16
Vertical Angle Tilt Correction	17
How to Enter Alphanumeric characters	19

3. ANGLE MEASUREMENT	21
Measuring Horizontal Angle Right and Vertical Angle	21
Switching Horizontal Angle Right/Left	22
Measuring from the Required Horizontal Angle	22
Setting by Holding the Angle	22
Setting a Horizontal Angle from the Keys	23
Vertical Angle Percent Grade(%) Mode	23
Repetition Angle Measurement	24
Buzzer Sounding for Horizontal Angle °90 Increment	25
Compasses (vertical angle)	26

4. DISTANCE MEASUREMENT	27
Setting of the Atmospheric Correction	27
Setting of the Correction for Prism Constant	27
Distance Measurement (Continuous Measurement)	27
Distance Measurement (N-time Measurement/Single Measurement)	28
Fine Mode/Tracking Mode/Coarse Mode	29
Stake Out (S.O)	30
Offset Measurement	31
Angle Offset	32
Distance Offset Measurement	34
Plane Offset Measurement	36
Column Offset Measurement	38

5. COORDINATE MEASUREMENT	40
Setting Coordinate Values of Occupied Point	40
Setting Height of the Instrument	41
Setting Height of Target (Prism Height)	41
Execution of Coordinate Measuring	42

6. SPECIAL MODE (Menu Mode)	43
Application Measurement (PROGRAMS)	44
Remote Elevation measurement (REM)	44
Missing Line Measurement (MLM)	47
Setting Z Coordinate of Occupied Point	50
Area Calculation	53
Point to Line Measurement	56
Setting the GRID FACTOR	58
Setting Illumination of Display and Cross Hairs	59
Setting Mode1	60
Setting Minimum Reading	60
Auto Power Off	61
Vertical Angle Tilt correction(Tilt ON/OFF)	61
Heater ON/OFF	62
Setting RS232-C communication with external device	63

Setting Contrast of Display	64
ROAD	65
Input Start Point	66
Input Road Data	67
Search Data	71
Edit Data	71
Set OCC and BS	72
Setout Road	74
Select a File	75
Initialize ROAD data	75
<hr/>	
7. DATA COLLECTION	76
Preparation	78
Selecting a File for Data Collection	78
Selecting a Coordinate File for Data Collection	79
Occupied Point and Backsight Point	79
Operational Procedure of "DATA COLLECT"	82
Data Collect Offset Measurement mode	85
Angle Offset Measurement.	85
Distance Offset Measurement	87
Plane Offset Measurement	89
Column Offset Measurement	91
NEZ Auto Calculation	92
Point to Line Measurement	93
To change to the point to line measurement	93
Executing a point to line measurement	94
Editing PCODE Library [PCODE INPUT]	95
Setting Parameter of Data Collect [CONFIG]	96
<hr/>	
8. LAYOUT	97
Preparation	101
Setting the GRID FACTOR	101
Selecting Coordinate Data File	102
Setting Occupied Point	102
Setting Backsight Point	104
Executing a Layout	106
Layout of Coordinates of Point to Line	108
Setting a New Point	109
Side Shot Method	109
Resection Method	111
<hr/>	
9. MEMORY MANAGER MODE	115
Display Internal Memory Status	116
Searching Data	117
Measured Data Searching	117
Coordinate Data Searching	119
PCODE LIBRARY Searching	120
FILE MAINTENANCE	121
Rename a File	122
Searching Data in a File	122
Deleting a File	123
Coordinate Data DirectKey Input	124
Coordinate data input	125
PTL (Point to Line) data input	126
Delete a Coordinate Data from a File	127
Editing PCODE Library	128
Data Communications	128
Sending Data	129
Loading Data	130
Setting Parameter of Data Communications	131
<hr/>	
10. SET AUDIO MODE	132
<hr/>	
11. SETTING THE PRISM CONSTANT VALUE	133

12. SETTING ATMOSPHERIC CORRECTION	134
Calculation of Atmospheric Correction	134
Setting of Atmospheric Correction Value	134
<hr/>	
13. CORRECTION FOR REFRACTION AND EARTH CURVATURE	139
Distance Calculation Formula	139
<hr/>	
14. POWER SOURCE AND CHARGING	140
On-board Battery	140
<hr/>	
15. DETACH/ATTACH OF TRIBRACH	142
<hr/>	
16. SELECTING MODE	143
Items of the Selecting Mode	143
How to Set Selecting Mode	145
<hr/>	
17. CHECK AND ADJUSTMENT	147
Checking and adjusting of instrument constant	147
Checking the Optical Axis	148
Checking/Adjusting the Theodolite Functions	149
Checking/Adjusting the Plate Level	150
Checking/Adjusting the Circular Level	150
Adjustment of the Vertical Cross-hair	151
Collimation of the Instrument	152
Checking/Adjusting the Optical Plummet Telescope	153
Adjustment of Vertical Angle 0 Datum	154
How to Set the Instrument Constant Value	155
Reference frequency check mode	156
<hr/>	
18. PRISM SYSTEM	157
<hr/>	
19. ERROR DISPLAYS	158
<hr/>	
20. SPECIFICATIONS	160
<hr/>	
APPENDIX	163
Precaution when Charging or Storing Batteries	163

1 NOMENCLATURE AND FUNCTIONS

1.1 Nomenclature

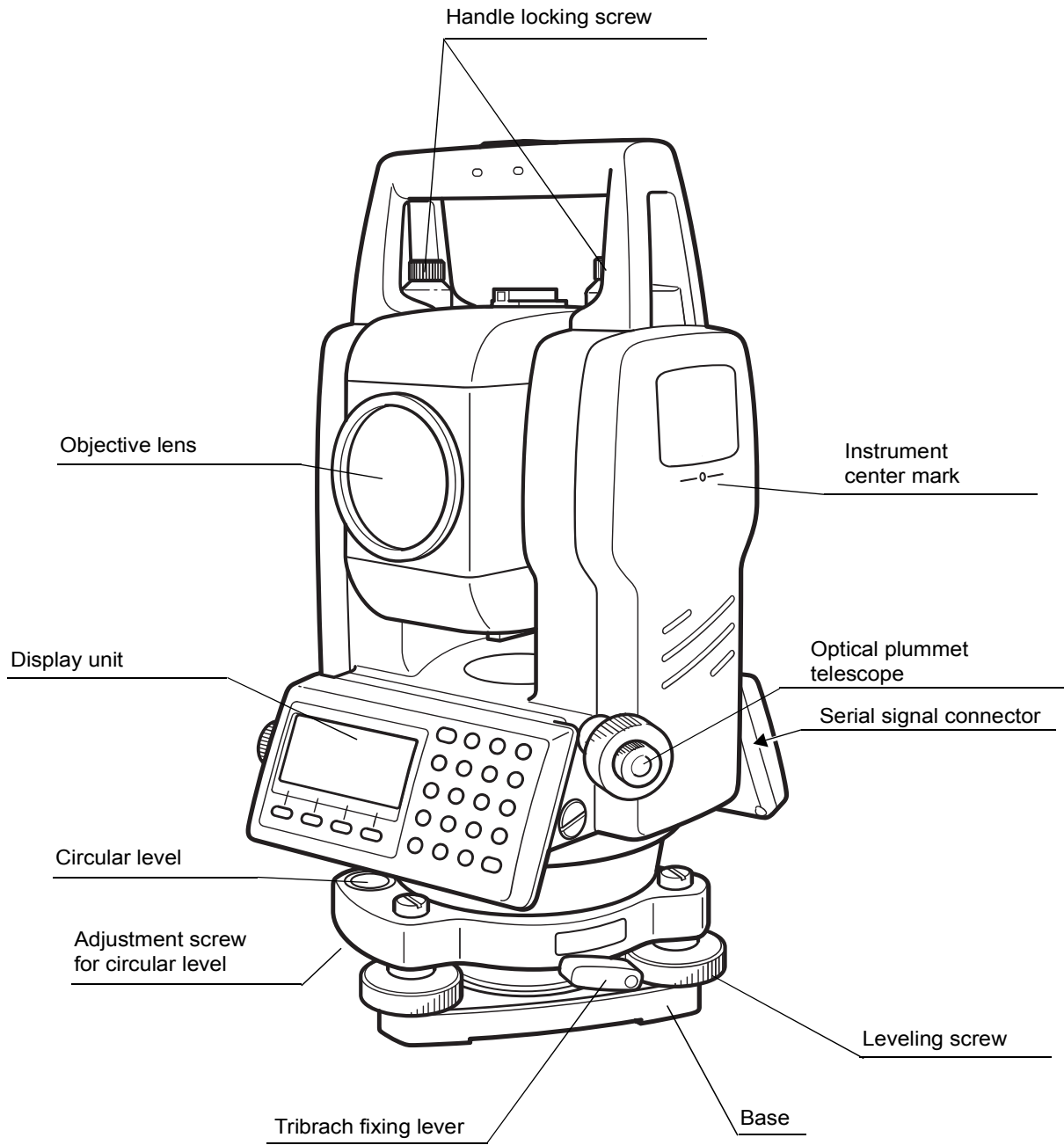

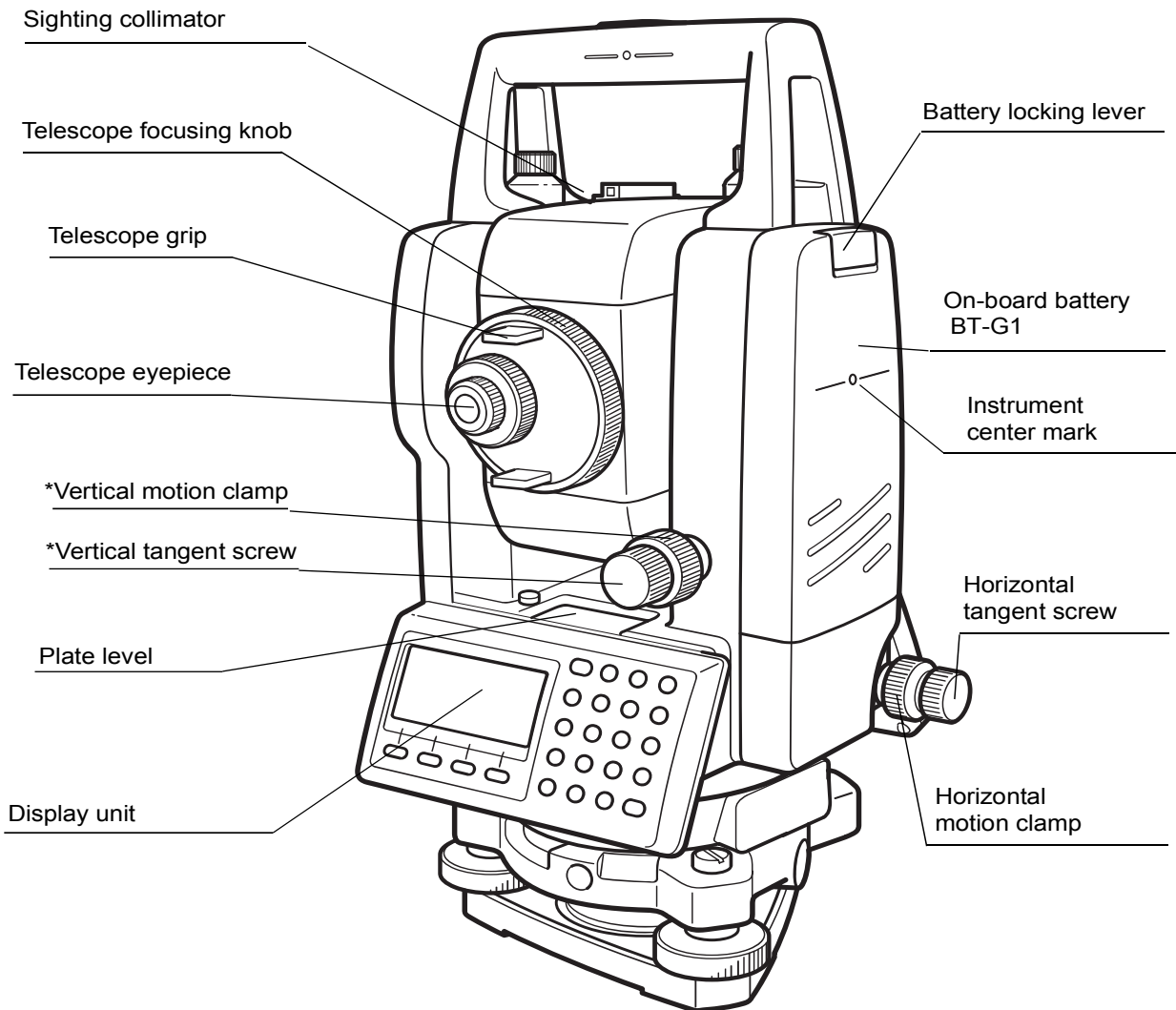

*The position of vertical motion clamp and Vertical tangent screw will differ depending on the market.

1.2. Display

• Display

The display uses a dot matrix LCD which has 4 lines and 20 characters per line. In general, the upper three lines display measured data, and the bottom line displays the soft key function which changes with the measuring mode.

• Contrast and Illumination

The contrast and illumination of display window are adjusted. see Chapter 6 "SPECIAL MODE (Menu Mode)" or section 1.5 "Star key mode".

• Heater (Automatic)

The built-in automatic heater functions when the temperature is below °C. This keeps the display's speed up at temperatures lower than °C. To set the heater ON/OFF, see section 6.4.4 "Heater ON/OFF". The operating time will become short if a heater is used.

• Example

V: 90°10'20"
HR: 120°30'40"

0SET HOLD HSET P1↓

Angle measurement mode

V-angle : 90°10'20"
H-angle : 40°30'120

Feet unit

HR: 120°30'40"
HD* 123.45 f
VD: 12.34 f
MEAS MODE S/A P1↓

Horizontal-angle : 120°30'40"
Horizontal distance : 123.45ft
Relative elevation : 12.34ft

HR: 120°30'40"
HD* 65.432 m
VD: 12.345 m
MEAS MODE S/A P1↓

Distance measurement mode

Horizontal-angle : 120°30'40"
Horizontal distance : 65.432m
Relative elevation : 12.345m

Feet and inch unit

HR: 120°30'40"
HD* 123.04.6f
VD: 12.03.4f
MEAS MODE S/A P1↓

Horizontal-angle : 120°30'40"
Horizontal distance : 123ft4in6/8in
Relative elevation : 12ft3in4/8in

• Display marks

Display	Contents	Display	Contents
V	V-angle	[EDM working
HR	H-angle right	m	Meter unit
HL	H-angle left	f	Feet and inch unit
HD	Horizontal distance		
VD	Relative elevation		
SD	Slope distance		
N	N coordinate		
E	E coordinate		
Z	Z coordinate		

1.3 Operating Key

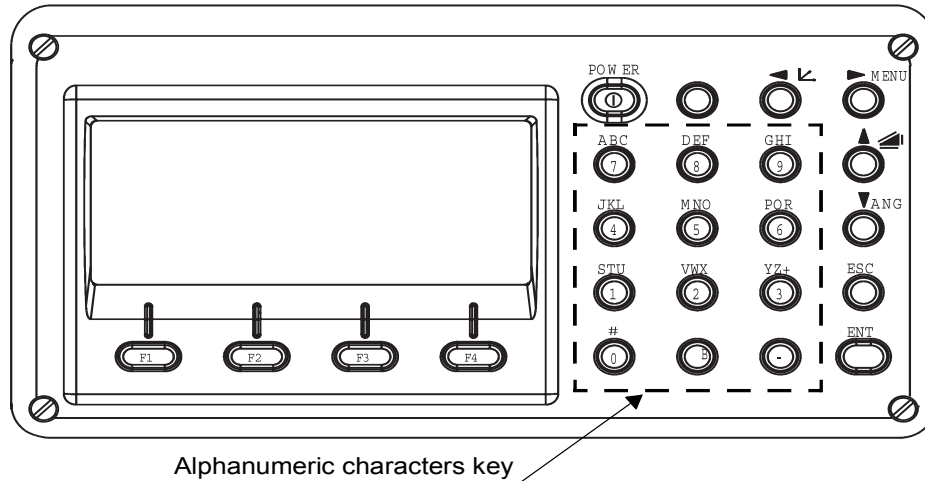

Keys	Name of Key	Function
H	Star key	Star key mode is used for each presetting or displaying as follows. 1 Contrast of the display 2 Reticle illumination 3 Back Light 4 Tilt correction 5 Set audio mode
	Coordinate meas.key	Coordinate measurement mode
	Distance meas.key	Distance measurement mode.
ANG	Angle meas.key	Angle measurement mode
POWER	Power source key	ON/OFF of power source
MENU	Menu key	Switches menu mode and normal mode. To set application measurements and adjust in the menu mode.
ESC	Escape key	<ul style="list-style-type: none"> Returning to the measurement mode or previous layer mode from the mode set. To be DATA COLLECTION mode or LAYOUT mode directly from the normal measurement mode. It is also possible to use as Record key in normal measurement mode. To select function of Escape key, see Chapter 16 "SELECTING MODE"
ENT	Enter key	Press at the end of inputting values.
F1-F4	Soft key (Function key)	Responds to the message displayed.

1.4 Function Key (Soft Key)

The Soft Key message is displayed at the bottom line of display. The functions are according to the displayed message.

Angle measurement mode

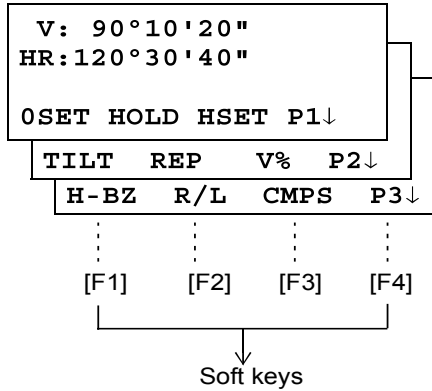

Distance measurement mode

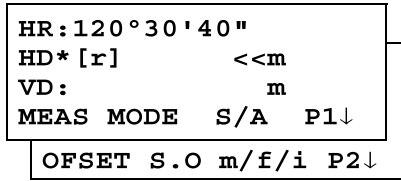

Coordinates measurement mode

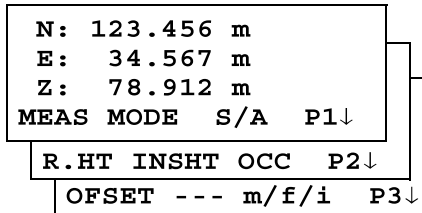

Angle measurement

Page	Soft key	Display mark	Function
1	F1	OSET	Angle of Horizontal is set to 0°00'00"
	F2	HOLD	Hold the horizontal angle
	F3	HSET	Sets a required horizontal angle by entering numerals.
	F4	P1↓	The function of soft keys is shown on next page (P2).
2	F1	TILT	Setting Tilt Correction If ON, the display shows tilt correction value.
	F2	REP	Repetition angle measurement mode
	F3	V%	Vertical angle percent grade(%) mode
	F4	P2↓	The function of soft keys is shown on next page (P3).
3	F1	H-BZ	Sets the buzzer sound for every horizontal angle 90°
	F2	R/L	Switches R/L rotation of horizontal angle.
	F3	CMPS	Switches the COMPASS ON/OFF of vertical angle.
	F4	P3↓	The function of soft keys is shown on next page (P1).

Distance measurement mode

1	F1	MEAS	Start measuring
	F2	MODE	Sets a measuring mode, Fine/Coarse/Tracking
	F3	S/A	Select set audio mode
	F4	P1↓	The function of soft keys is shown on next page (P2).
2	F1	OFSET	Select Off-set measurement mode
	F2	S.O	Select stake out measurement mode
	F3	m/f/i	Switches meter, feet or feet and inch unit.
	F4	P2↓	The function of soft keys is shown on next page (P1).

Coordinate measurement mode

1	F1	MEAS	Start measuring
	F2	MODE	Sets a measuring mode, Fine/Coarse/Tracking
	F3	S/A	Select set audio mode
	F4	P1↓	The function of soft keys is shown on next page (P2).
2	F1	R.HT	Sets a prism height by input values.
	F2	INSHT	Sets an instrument height by input values.
	F3	OCC	Sets an instrument coordinate point by input values.
	F4	P2↓	The function of soft keys is shown on next page (P3).
3	F1	OFSET	Select Off-set measurement mode
	F3	m/f/i	Switches meter, feet or feet and inch unit.
	F4	P3↓	The function of soft keys is shown on next page (P1).

1.5 Star key mode

Press the (H) key to view the instrument options.

The following instrument options can be selected from the (H):

1. Adjustment the contrast of the display (0 to 9 steps) [▲ or ▼]
2. Adjustment the reticle illumination (1 to 9 steps) [◀ or ▶]
3. Turn the backlight of the display ON/OFF [F1]
4. Setting Tilt Correction [F2]
5. S/A (set audio) mode [F4]

Note: Star key mode does not function when the same function as the function assigned to the star key mode is performed from the main routine.

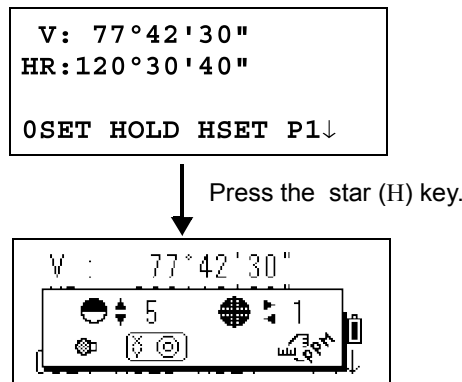

key	Display mark	Function
F1		Turn the backlight of the display ON/OFF
F2		Setting Tilt Correction If ON, the display shows tilt correction value.
F4		The light acceptance quantity level for the EDM (SIGNAL), the atmospheric correction value (PPM) and correction value of prism constant (PSM) are displayed.
▲ or ▼		Adjust the contrast of the display (0 to 9 steps)
◀ or ▶		Adjust the Reticle Illumination (1 to 9 steps) ON/OFF of the reticle illumination is linked with ON/OFF of the backlight.

•**Adjustment the contrast (0 to 9) of the display**

This enable you to adjust the contrast of the display.
Press the up or down arrow keys to adjust the contrast.

•**Adjustment the reticle illumination (1 to 9)**

This enable you to adjust the reticle illumination.

•**Turn the display back light ON/OFF**

To turn the back light ON, press the [F1] key. Press [F1] again to turn the back light OFF.

•**Tilt correction**

The tilt setting mode performed here will not be memorized after powering OFF. To set TILT correction in the initialized setting (it is memorized after powering OFF), see Section 6.4.3 “Vertical Angle Tilt correction (Tilt ON/OFF)” .

•**Set audio mode**

The light acceptance quantity level (Signal level) is displayed in this mode.

When reflected light from the prism is received, a buzzer sounds. This function is good for easy collimation when the target is difficult to find.

Press the [F4] key to view the set audio screen.

(1) To stop the buzzer, refer to Chapter 16 “SELECTING MODE”.

(2) Also, it is possible to display the signal level in Distance Measuring Mode.

The temperature, pressure, PPM, and PSM can be viewed in set audio mode.

Refer to Chapter 10 “SET AUDIO MODE”, Chapter 11 “SETTING THE PRISM CONSTANT VALUE” and Chapter 12 “SETTING ATMOSPHERIC CORRECTION” , for further instructions.

1.6 Serial signal RS-232C connector

The serial signal connector is used for connecting the FTS 300 series with a computer or geo-FENNEL Data Collector, which enables the computer to receive measured data from the FTS 300 series or to send preset data of horizontal angle, etc. to it.

•The following data will be output at each mode.

Mode	Output
Angle mode (V,HR or HL)	V,HR (or HL)
Horizontal distance mode (HR, HD, VD)	V,HR, HD, VD
Slope distance mode (V, HR,SD)	V,HR, SD,HD
Coordinate mode	N, E, Z, HR (or V,HR,SD,N,E,Z)

•The display and the output at the coarse mode are the same as the contents above.

•Output at the tracking mode is displayed as distance data only.

The details necessary for the connection with the FTS 300 Series are obtained from its Interface Manual which is optionally available. Please refer to the manual.

2 PREPARATION FOR MEASUREMENT

2.1 Setting Instrument Up For Measurement

Mount the instrument to the tripod. Level and center the instrument precisely to insure the best performance. Use tripods with a tripod screw of 5/8 in. diameter and 11 threads per inch, such as the Type geo-FENNEL wide-frame wooden tripod.

Reference: Leveling and Centering the Instrument

1. Setting up the Tripod

First, extend the extension legs to suitable lengths and tighten the screws on their midsections.

2. Attaching the Instrument on the Tripod Head

Place the instrument carefully on the tripod head and slide the instrument by loosening the tripod screw. If the plumb bob is positioned right over the center of the point, slightly tighten the tripod screw.

3. Roughly Leveling the Instrument by Using the Circular Level

- 1 Turn the leveling screws A and B to move the bubble in the circular level. The bubble is now located on a line perpendicular to a line running through the centers of the two leveling screws being adjusted.

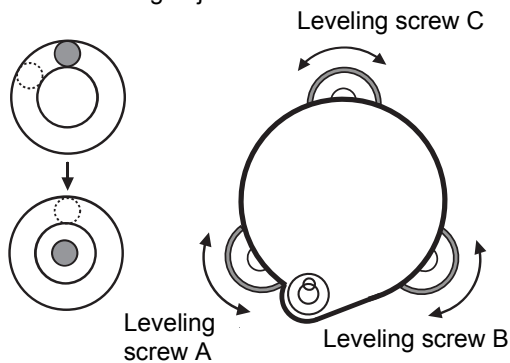

- 2 Turn the leveling screw C to bring the bubble to the center of the circular level.

4. Centering by Using the Plate Level

- 1 Rotate the instrument horizontally by using the Horizontal motion/clamp screw and place the plate level parallel with the line connecting leveling screws A and B, and then bring the bubble to the center of the plate level by turning leveling screws A and B.

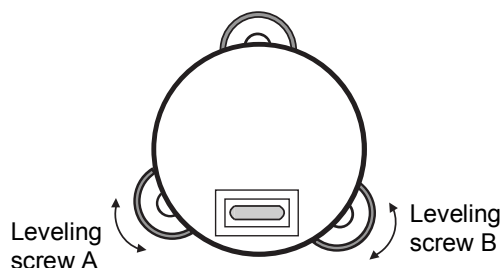

- 2 Rotate the instrument 90° (100g) around its vertical axis and turn the remaining leveling screw or C to center the bubble once more.

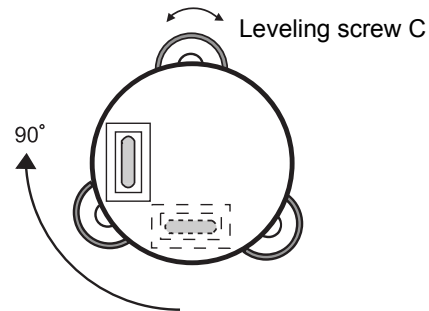

- 3 Repeat the procedures 1 and 2 for each 90° (100g) rotation of the instrument and check whether the bubble is correctly centered for all four points.

5. Centering by Using the Optical Plummet Telescope

Adjust the eyepiece of the optical plummet telescope to your eyesight. Slide the instrument by loosening the tripod screw, place the point on the center mark, and then tighten the tripod screw. Sliding the instrument carefully not to rotate that allows you to get the least dislocation of the bubble.

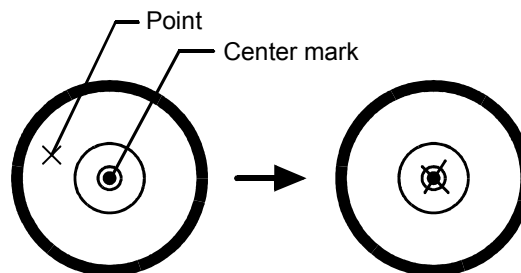

6. Completely Leveling the Instrument

Leveling the instrument precisely in a similar way to 4. Rotate the instrument and check to see that the bubble is in the center of the plate level regardless of telescope direction, then tighten the tripod screw hard.

2.2 Power Switch Key ON

- 1 Confirm the instrument is leveled.
- 2 Turn the power switch ON.

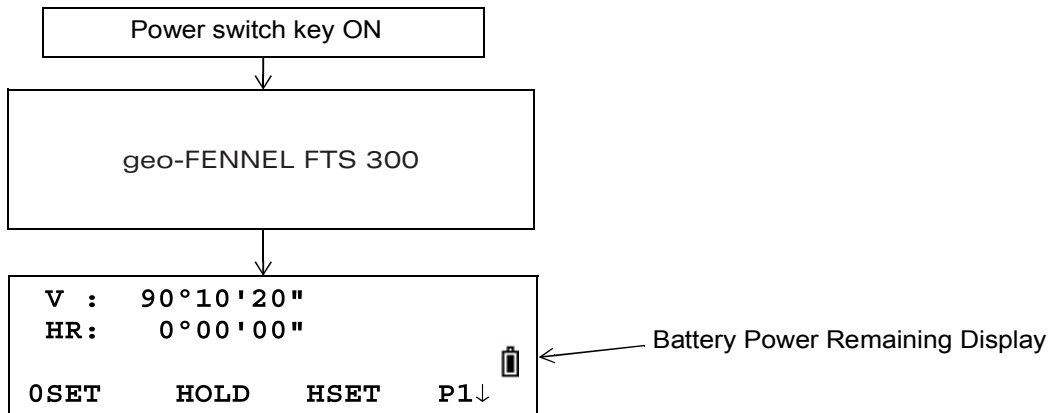

- Confirm the battery power remaining display. Replace with charged battery or charge when battery level is low or indicates "Battery empty". see Section 2.3 "Battery Power Remaining Display" .
- **Contrast adjustment**
You can confirm prism constant value (PSM) , atmospheric correction value (PPM) and you can also adjust the contrast of the display when the instrument is turned on.
To display this screen, see Chapter 16 "SELECTING MODE" ..

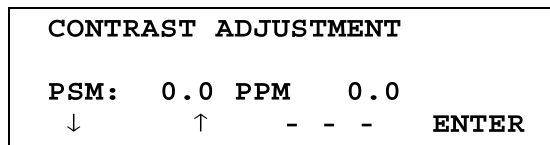

This enables you to adjust the brightness by pressing the [F1](↓) or [F2](↑) key.
To memorize the setting value after powering off, press [F4](ENTER) key.

2.3 Battery Power Remaining Display

Battery power remaining display indicates the power condition.

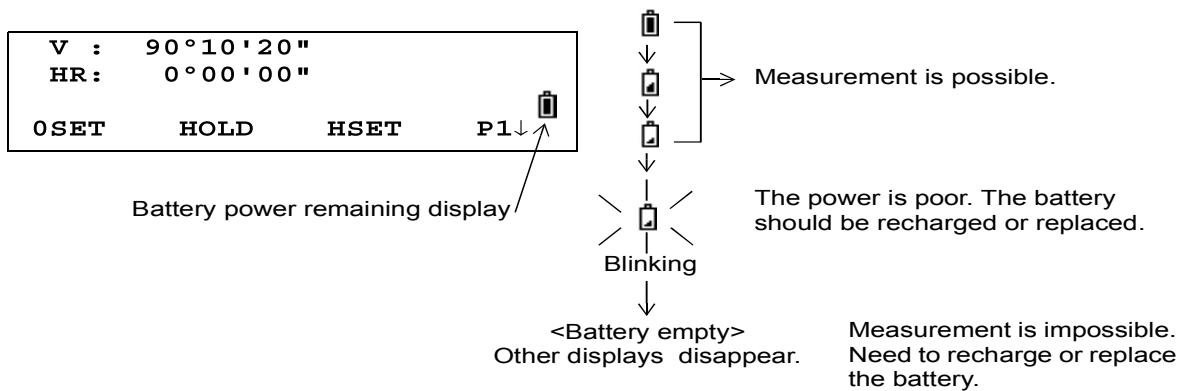

- Note:
- 1 The battery operating time will vary depending on the environmental conditions such as ambient temperature, charging time, the number of times of charging and discharging etc. It is recommended for safety to charge the battery beforehand or to prepare spare full charged batteries.
 - 2 For general usage of the battery, see Chapter 14 "POWER SOURCE AND CHARGING".
 - 3 The battery power remaining display shows the power level regarding to the measurement mode now operating. The safety condition indicated by the battery power remaining display in the angle measurement mode does not necessarily assure the battery's ability to be used in the distance measurement mode. It may happen that the mode change from the angle mode to the distance mode will stop the operation because of insufficient battery power for the distance mode which consumes more power than angle mode.

2.4 Vertical Angle Tilt Correction

When the tilt sensors are activated, automatic correction of vertical angle for mislevelment is displayed.

To ensure a precise angle measurement, tilt sensors must be turned on. The display can also be used to fine level the instrument. If the (TILT OVER) display appears the instrument is out of automatic compensation range and must be leveled manually.

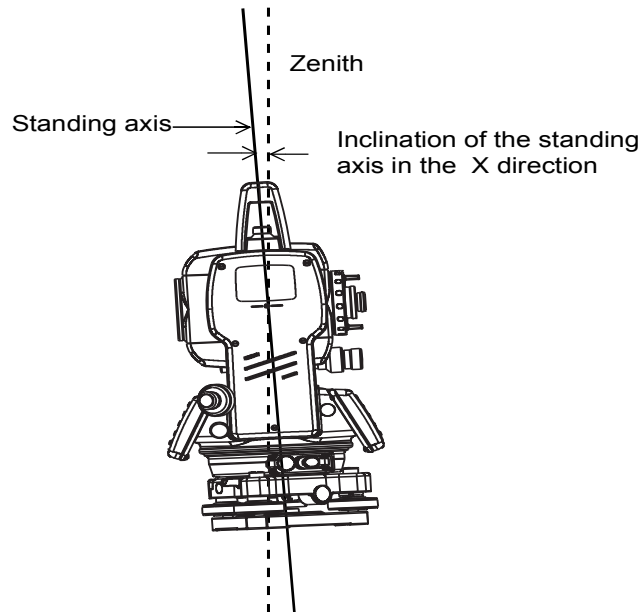

- FTS 300 compensates the vertical angle reading due to inclination of the standing axis in the X direction.

When the instrument is out of compensation. (TILT OVER)

V :	°	'	"
HR :	°	'	"
<X TILT OVER>			

Standing Axis in the X direction
out of range

- To set auto tilt correction from the moment that power is on, see Section 6.4.3 "Vertical Angle Tilt correction (Tilt ON/OFF)" .
- The display of Vertical angle is unstable when instrument is on an unstable stage or a windy day. You can turn off the auto tilt correction function of V angle in this case.

- **Setting Tilt Correction by Soft Key**

To enable you to select tilt ON/OFF function. setting is not memorized after power is OFF.
 [Example] Setting X Tilt OFF

Operating procedure	Option	Display
1 Press [F4] key to get the function page 2.	[F4]	<pre>V : 90°10'20" HR: 120°30'40" OSET HOLD HSET P1↓ TILT REP V% P2↓</pre>
2 Press [F1](TILT) key. In case ON is already selected, the display shows tilt correction value.	[F1]	<pre>TILT SENSOR: [X-ON] X: -0°00'25" X-ON --- OFF ---</pre>
3 Press [F3](OFF) key.	[F3]	<pre>TILT SENSOR: [OFF] X-ON --- OFF ---</pre>
4 Press [ESC] key.	[ESC]	<pre>V : 90°10'20" HR: 120°30'40" OSET HOLD HSET P1↓</pre>
<ul style="list-style-type: none"> • The setting mode performed here will not be memorized after powering OFF. To set TILT correction in the initialized setting (it is memorized after powering OFF), see Section 6.4.3“Vertical Angle Tilt correction (Tilt ON/OFF)” . 		

2.5 How to Enter Alphanumeric characters

This enables you to enter alphanumeric characters such as the instrument height, prism height, occupied point, backsight point etc..

2.5.1 How to Enter Alphanumeric Characters

•How to select a item

[Example setting] Occupied point in the data collection mode.

The arrow indicates a item to enter.

The arrow line moves up or down when the [▼] key or [▲] key is pressed.

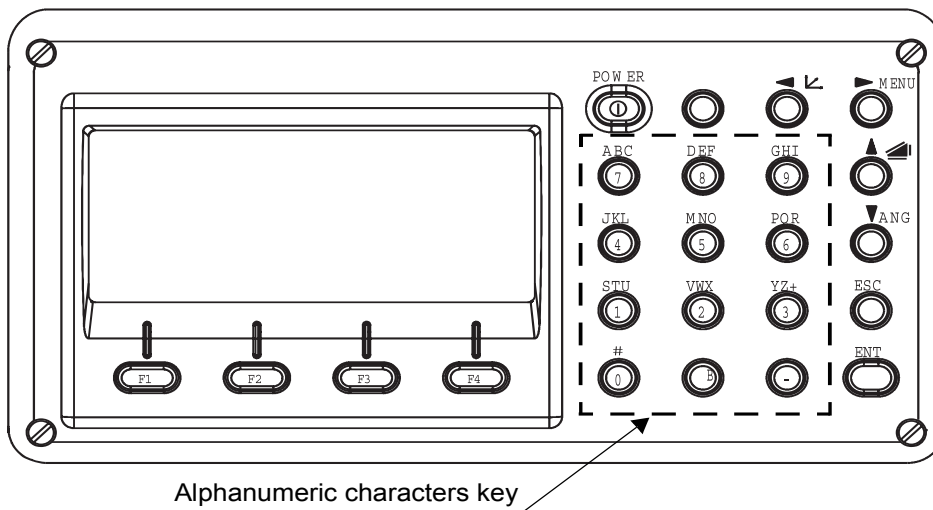
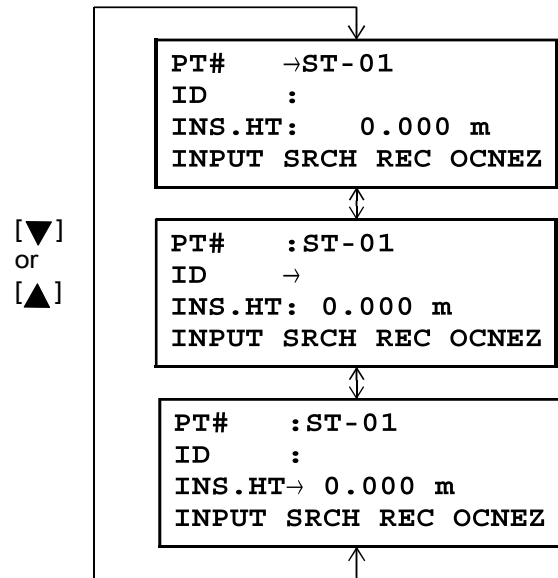

•How to enter characters

[Example setting] geo-FENNEL

- 1** Move the arrow to enter a item using the [▼] or [▲] key.

```
PT#    →
ID     :
INS.HT: 0.000 m
INPUT SRCH REC OCNEZ
```

- 2** Press the [F1] (INPUT) key.
The arrow changes to the equal (=) .
The instrument switches to numerical input mode.

```
PT#    =
ID     :
INS.HT: 0.000 m
[ALP] [SPC] [CLR] [ENT]
```

- 3** Press the [F1] [ALP] key.
The instrument switches to alphabetical input mode.

```
PT#    =
ID     :
INS.HT: 0.000 m
[NUM] [SPC] [CLR] [ENT]
```

- 4** Enter letters of the alphabet by pressing the alphanumeric characters key.
Example: [1] (STU) key is pressed twice.

```
PT#    =T
ID     :
INS.HT: 0.000 m
[NUM] [SPC] [CLR] [ENT]
```

- 5** Enter other letters of the alphabet in the same way.

```
PT#    =geo-FENNEL
ID     :
INS.HT: 0.000 m
[NUM] [SPC] [CLR] [ENT]
```

- 6** Press the [F1] (NUM) key, again.
The instrument switches back to numerical input mode.

```
PT#    =geo-FENNEL
ID     :
INS.HT: 0.000 m
[ALP] [SPC] [CLR] [ENT]
```

- 7** Enter numbers by pressing the alphanumeric characters key.

Example: [-], [1] key is pressed.

```
PT#    = geo-FENNEL
ID     :
INS.HT: 0.000 m
[ALP] [SPC] [CLR] [ENT]
```

- 8** Press [F4](ENT) key.
The arrow moves to next item.

Select next character in the same manner.

```
PT#    = geo-FENNEL
ID     →
INS.HT: 0.000 m
[NUM] [SPC] [CLR] [ENT]
```

- To correct a character, move the cursor to correct character by pressing [◀] or [▶] key and enter again.

3 ANGLE MEASUREMENT

3.1 Measuring Horizontal Angle Right and Vertical Angle

Make sure the mode is in Angle measurement.

Operating procedure	Operation	Display
1 Collimate the 1st target (A). 2 Set horizontal angle of target A at 0° 00' 00". Press the [F1](0 set) key and press the [F3](YES) key.	Collimate A	V : 90°10'20" HR: 120°30'40" 0SET HOLD HSET P1↓
	[F1]	H ANGLE 0 SET > OK? --- --- [YES] [NO]
3 Collimate the 2nd target (B). The required V/H angle to target B will be displayed.	[F3]	V : 90°10'20" HR: 0°00'00" 0SET HOLD HSET P1↓
	Collimate B	V : 98°36'20" HR: 160°40'20" 0SET HOLD HSET P2↓

Reference : How to Collimate

- 1 Point the telescope toward the light. Turn the diopter ring and adjust the diopter so that the cross hairs are clearly observed. (Turn the diopter ring toward you first and then backward to focus.)
- 2 Aim the target at the peak of the triangle mark of the sighting collimator. Allow a certain space between the sighting collimator and yourself for collimating.
- 3 Focus the target with the focusing knob.

*If parallax is created between the cross hairs and the target when viewing vertically or horizontally while looking into the telescope, focusing is incorrect or diopter adjustment is poor. This adversely affects precision in measurement or survey. Eliminate the parallax by carefully focusing and using diopter adjustment.

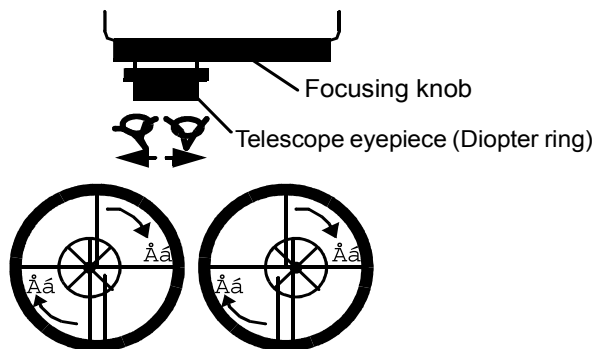

3.2 Switching Horizontal Angle Right/Left

Make sure the mode is Angle measurement.

Operating procedure	Operation	Display
1 Press the [F4](↓) key twice to get the function on page 3. 2 Press the [F2](R/L) key. The mode Horizontal angle Right (HR) switches to Left (HL) mode. 3 Measure as HL mode.	[F4] twice [F2]	<div style="border: 1px solid black; padding: 5px; margin-bottom: 5px;"> V : 90°10'20" HR: 120°30'40" 0SET HOLD HSET P1↓ TILT REP V% P2↓ H-BZ R/L CMPS P3↓ </div> <div style="border: 1px solid black; padding: 5px;"> V : 90°10'20" HL: 239°29'20" H-BZ R/L CMPS P3↓ </div>
<ul style="list-style-type: none"> Every time pressing the [F2](R/L) key, HR/HL mode switches. 		

3.3 Measuring from the Required Horizontal Angle

3.3.1 Setting by Holding the Angle

Make sure the mode is angle measurement.

Operating procedure	Operation	Display
1 Set the required horizontal angle, using Horizontal tangent screw. 2 Press the [F2](HOLD) key. 3 Collimate the target. 4 Press the [F3](YES) key to finish holding the horizontal angle.*1) The display turns back to normal angle measurement mode.	Display angle [F2] Collimate [F3]	<div style="border: 1px solid black; padding: 5px; margin-bottom: 5px;"> V : 90°10'20" HR: 130°40'20" 0SET HOLD HSET P1↓ </div> <div style="border: 1px solid black; padding: 5px; margin-bottom: 5px;"> H ANGLE HOLD HR= 130°40'20" > SET ? --- --- [YES] [NO] </div> <div style="border: 1px solid black; padding: 5px;"> V : 90°10'20" HR: 130°40'20" 0SET HOLD HSET P1↓ </div>
*1) To return to the previous mode, press the [F4](NO) key.		

3.3.2 Setting a Horizontal Angle from the Keys

Make sure the mode is Angle measurement.

Operating procedure	Operation	Display
1 Collimate the target. 2 Press the [F3](HSET) key. 3 Input the required horizontal angle by using keys. *1) For example :70°40'20" When completed, normal measuring from the required Horizontal angle is possible.	Collimate	V : 90°10'20" HR: 170°30'20" OSET HOLD HSET P1↓
	[F3]	H ANGLE SET HR= --- --- [CLR] [ENT]
	70.4020 [F4]	V : 90°10'20" HR: 70°40'20" OSET HOLD HSET P1↓
*1) To enter Alphanumeric characters, see Section 2.5 "How to Enter Alphanumeric characters".		

3.4 Vertical Angle Percent Grade(%) Mode

Make sure the mode is Angle measurement.

Operating procedure	Operation	Display
1 Press the [F4](↓) key to get the function on page 2. 2 Press the [F3](V%) key. *1)	[F4]	V : 90°10'20" HR: 170°30'20" OSET HOLD HSET P1↓ TILT REP V% P2↓
	[F3]	V : -0.30 % HR: 170°30'20" TILT REP V% P1↓
*1) Every time pressing the [F3](V%) key, the display mode switches. • When the measurement is carried out over $\pm 45^\circ$ ($\pm 100\%$) from the horizontal, the display shows <OVER>.		

3.5 Repetition Angle Measurement

•Repetition angle measurement can be done by horizontal angle right measurement mode.

Make sure the mode is Horizontal Angle Right measurement.

Operating procedure	Operation	Display
1 Press the [F4](↓) key to get the function on page 2.	[F4]	<pre>V : 90°10'20" HR: 170°30'20" OSET HOLD HSET P1↓ TILT REP V% P2↓</pre>
2 Press the [F2](REP)key.	[F2]	<pre>REPETITION ANGLE > OK? --- --- [YES] [NO]</pre>
3 Press the [F3](YES) key.	[F3]	<pre>REP-ANGLE COUNT [0] Ht: 0°00'00" Hm: OSET V/H REL HOLD</pre>
4 Collimate the target A and press the [F1] (OSET) key.	Collimate A [F1]	<pre>REPETITION ANGLE INITIALIZE > OK? --- --- [YES] [NO]</pre>
5 Press the [F3] (YES) key.	[F3]	<pre>REP-ANGLE COUNT [0] Ht: 0°00'00" Hm: OSET V/H REL HOLD</pre>
6 Collimate the target B using the horizontal clamp and tangent screw. Press the [F4](HOLD) key.	Collimate B [F4]	<pre>REP-ANGLE COUNT [1] Ht: 45°10'00" Hm: 45°10'00" OSET V/H REL HOLD</pre>
7 Recollimate target A using the horizontal clamp and tangent screw, and press the [F3](REL)key.	Collimate A [F3]	<pre>REP-ANGLE COUNT [1] Ht: 45°10'00" Hm: 45°10'00" OSET V/H REL HOLD</pre>
8 Recollimate target B using the horizontal clamp and tangent screw, and press the [F4](HOLD) key.	Collimate B [F4]	<pre>REP-ANGLE COUNT [2] Ht: 90°20'00" Hm: 45°10'00" OSET V/H REL HOLD</pre>
9 Repeat 7 to 8 to measure the desired number of repetitions.		<pre>REP-ANGLE COUNT [4] Ht: 180°40'00" Hm: 45°10'00" OSET V/H REL HOLD</pre> <p>[Example] 4 measurement</p>

<p>10 To return to the normal angle mode, press the [F2](V/H) key or [ESC] key.</p>	<p>[ESC] or [F2]</p>	<pre> REPETITION ANGLE Exit > OK? --- --- [YES] [NO] </pre>
<p>11 Press the [F3](YES) key.</p>	<p>[F3]</p>	<pre> V : 90°10'20" HR: 170°30'20" 0SET HOLD HSET P1↓ </pre>
<ul style="list-style-type: none"> Horizontal angle can be accumulated up to (3600°00'00" – minimum reading) (horizontal angle right). In case of 5 second reading, horizontal angle can be accumulated up to +3599°59'55". Error will be displayed when the results differ from first measurement by more than ±30". 		

3.6 Buzzer Sounding for Horizontal Angle 90° Increments

When the horizontal angle falls in the range of less than ± 1° of 0°, 90°, 180° or 270°, the buzzer sounds. Buzzer stops only when the horizontal angle is adjusted to 0°00'00", 90°00'00", 180°00'00" or 270°00'00".

This setting is not memorized after powering off. Refer to 16 "SELECTING MODE" to set the initial setting (memorized after powering off).

Make sure the mode is Angle measurement.

Operating procedure	Operation	Display
<p>1 Press the [F4](↓) key twice to get the function on page 3.</p>	<p>[F4] twice</p>	<pre> V : 90°10'20" HR: 170°30'20" 0SET HOLD HSET P1↓ H-BZ R/L CMPS P3↓ </pre>
<p>2 Press the [F1](H-BZ) key. The data previously set is shown.</p>	<p>[F1]</p>	<pre> H-ANGLE BUZZER [OFF] [ON] [OFF] --- ENTER </pre>
<p>3 Press the [F1](ON) key or [F2](OFF) key to select the buzzer ON/OFF.</p>	<p>[F1] or [F2]</p>	<pre> H-ANGLE BUZZER [ON] [ON] [OFF] --- ENTER </pre>
<p>4 Press the [F4](ENTER) key.</p>	<p>[F4]</p>	<pre> V : 90°10'20" HR: 170°30'20" 0SET HOLD HSET P1↓ </pre>

3.7 Compasses (vertical angle)

Vertical angle is displayed as shown below.

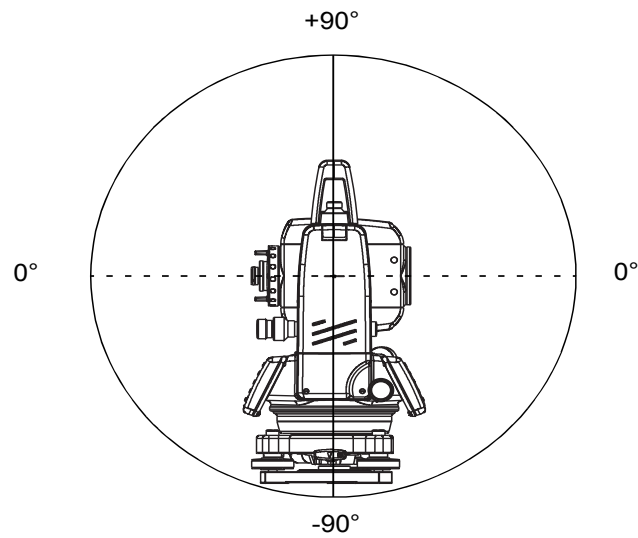

Operating procedure	Operation	Display
1 Press the [F4](↓) key twice to get the function on page 3.	[F4] twice	V : 98°10'20" HR: 170°30'20" 0SET HOLD HSET P1↓ H-BZ R/L CMPS P3↓
2 Press the [F3](CMPS) key. *1)	[F3]	V : - 8°10'20" HR: 170°30'20" H-BZ R/L CMPS P3↓
*1) Every time pressing the [F3](CMPS) key, the display mode switches.		

4 DISTANCE MEASUREMENT

4.1 Setting of the Atmospheric Correction





When setting the atmospheric correction, obtain the correction value by measuring the temperature and pressure. Refer to Section 12.2 "Setting of Atmospheric Correction Value".

4.2 Setting of the Correction for Prism Constant

geo-FENNEL's prism constant value is 0. Set correction for prism at 0. If the prism is of another manufacture, the appropriate constant shall be set beforehand. Refer to Chapter 11 "SETTING THE PRISM CONSTANT VALUE". The setting value is kept in the memory even after power is off.

4.3 Distance Measurement (Continuous Measurement)

Make sure the mode displays angle measurement.



Operating procedure	Operation	Display
1 Collimate the center of prism.	Collimate P	<pre>V : 90°10'20" HR: 120°30'40" 0SET HOLD HSET P1↓</pre>
2 Press the [] key. Distance measurement starts. *1),2)	[]	<pre>HR: 120°30'40" HD* [r] << m VD: m MEAS MODE S/A P1↓</pre>
The measured distances are shown. *3)~*5)		<pre>↓ HR: 120°30'40" HD* 123.456 m VD: 5.678 m MEAS MODE S/A P1↓</pre>
Pressing the [] key again, the display changes to horizontal (HR) and vertical (V) angle and slope distance(SD). *6)	[]	<pre>V : 90°10'20" HR: 120°30'40" SD* 131.678 m MEAS MODE S/A P1↓</pre>
<p>*1) When EDM is working, the "[" mark appears in the display. *2) To change mode from Fine to Coarse or Tracking, refer to section 4.5 "Fine Mode/Tracking Mode/Coarse Mode". To set the distance measurement when the instrument is powered on, refer to Chapter 16 "SELECTING MODE". *3) The distance unit indicator "m" (for meter) , "f" (for feet or feet inch) appears and disappears alternatively with buzzer sounds at every renewal of distance data. *4) Measurement may repeat automatically in the instrument if the result is affected by shimmer etc.. *5) To return to the normal measuring angle mode from a distance measuring mode, press the [ANG] key. *6) It is possible to choose the display order (HR, HD, VD) or (V, HR, SD) for initial measuring distance mode. Refer to Chapter 16 "SELECTING MODE".</p>		

4.4 Distance Measurement (N-time Measurement/Single Measurement)

When the number of times measurement is preset, the FTS 300 series measures the distance the set number of times. The average distance will be displayed.

When presetting the number of times as 1, it does not display the average distance, because of single measurement. Single measurement is set at the factory.

Make sure the mode displays angle measurement.

Operating procedure	Operation	Display
1 Collimate the center of prism.		<pre>V : 90°10'20" HR: 120°30'40" 0SET HOLD HSET P1↓</pre>
2 Press the [] key. Continuous measuring starts.*1)	[]	<pre>HR: 120°30'40" HD* [r] << m VD: m MEAS MODE S/A P1↓</pre>
3 Press [F1](MEAS) key while continuous measuring is exceeding. *2) The average value is displayed and "*" mark disappears. While EDM is working, press [F1](MEAS) key again, the mode will be changed to continuous measuring mode.	[F1]	<pre>HR: 120°30'40" HD* [n] << m VD: m MEAS MODE S/A P1↓</pre> <p style="text-align: center;">↓</p> <pre>HR: 120°30'40" HD: 123.456 m VD: 5.678 m MEAS MODE S/A P1↓</pre>
<p>*1) It is possible to set the measurement mode for N-times measurement mode or continuous measurement mode when the power is turned on. Refer to Chapter 16 "SELECTING MODE".</p> <p>*2) For setting the number of times (N-times) in the measurement, refer to Chapter 16 "SELECTING MODE".</p>		

•Choose meter /feet / feet+inch unit by soft key

It is possible to change the unit for distance measurement mode by soft key.

This setting is not memorized after power off. Refer to 16 "SELECTING MODE" to set at the initial setting (memorized after power off).

Operating procedure	Operation	Display
1 Press the [F4](P1↓) key to get the function on page 2	[F4]	<div style="border: 1px solid black; padding: 2px;"> HR: 120°30'40" HD* 2.000 m VD: 3.000 m MEAS MODE S/A P1↓ OFFSET S.O m/f/i P2↓ </div>
2 Every time pressing the [F3](m/f/i) key, the display unit will be changed. Every time pressing the [F3](m/f/i) key, the unit mode switches.	[F3]	<div style="border: 1px solid black; padding: 2px;"> HR: 120°30'40" HD* 6.560 f VD: 9.845 f OFFSET S.O m/f/i P2↓ </div>

4.5 Fine Mode/Tracking Mode/Coarse Mode

This setting is not memorized after power is off. Refer to Chapter 16"SELECTING MODE" to set at the initial setting (memorized after power is off).

- Fine Mode : This is a normal distance measuring mode.
The unit to be displayed: 0.2mm or 1mm. (0.001ft or 0.005ft)
Measurement time 0.2mm mode: approx. 2.8 sec.
1mm mode: approx. 1.2 sec.
- Tracking Mode : This mode measures in shorter time than in fine mode.
It is very useful when tailing the moving object or carrying out stake-out work.
The unit to be displayed: 10mm
Measuring time: approx. 0.4 sec.
- Coarse Mode : This mode measures in shorter time than in fine mode.
The unit to be displayed: 10mm or 1mm
Measuring time: approx. 0.7 sec.

Operating procedure	Operation	Display
1 Press the [F2](MODE) key from the distance measuring mode.*1) The initial character (F/T/C) of set mode is displayed . (F:Fine, T:Tracking, C:Coarse)	[F2]	<div style="border: 1px solid black; padding: 2px;"> HR: 120°30'40" HD* 123.456m VD: 5.678m MEAS MODE S/A P1↓ HR: 120°30'40" HD* 123.456m VD: 5.678m FINE TRACK COARSE F </div>
2 Press the [F1](FINE) key, [F2](TRACK) key, or [F3](COARSE) key.	[F1]~[F3]	<div style="border: 1px solid black; padding: 2px;"> HR: 120°30'40" HD* 123.456m VD: 5.678m MEAS MODE S/A P1↓ </div>
*1) To cancel the setting, press the [ESC] key.		

4.6 Stake Out (S.O)

The difference between the measured distance and the input stake out distance is displayed.

Measured distance — Stake out distance = Displayed value

- In stake out operation, you can select either horizontal distance (HD), relative elevation (VD) and slope distance (SD)

Operating procedure	Operation	Display
<p>1 Press the [F4](↓) key in the distance measuring mode to get the function on page 2.</p>	[F4]	<pre> HR: 120°30'40" HD* 123.456 m VD: 5.678 m MEAS MODE S/A P1↓ OFSET S.O m/f/i P2↓ </pre>
<p>2 Press the [F2](S.O) key.</p> <p>The data previously set is shown.</p>	[F2]	<pre> STAKE OUT HD : 0.000 m HD VD SD --- </pre>
<p>3 Select the measuring mode by pressing the [F1] to [F3] key.</p> <p>Example : Horizontal distance</p>	[F1]	<pre> STAKE OUT HD = 0.000 m --- --- [CLR] [ENT] </pre>
<p>4 Enter the distance for stake out. *1)</p>	Enter data [F4]	<pre> STAKE OUT HD : 100.000 m INPUT --- --- ENTER </pre>
<p>5 Collimate the target (Prism).</p> <p>Measuring starts.</p> <p>The difference between the measured distance and the stake out distance is displayed.</p>	Collimate P	<pre> HR: 120°30'40" dHD* [r] << m VD: m MEAS MODE S/A P1↓ ↓ HR: 120°30'40" dHD* 23.456 m VD: 5.678 m MEAS MODE S/A P1↓ </pre>
<p>6 Move the target until the difference becomes 0m.</p>		
<p>*1) Refer to section 2.5 "How to Enter Alphanumeric characters". To return to normal distance measurement mode, stake out distance to "0" m or turn the power off.</p>		

4.7 Offset Measurement

There are four offset measurement modes in the Offset Measurement.

- Angle offset
- Distance offset
- Plane offset
- Column offset

To show the offset measurement menu, press the [OFFSET] soft key from distance or coordinate measurement mode.

Example:

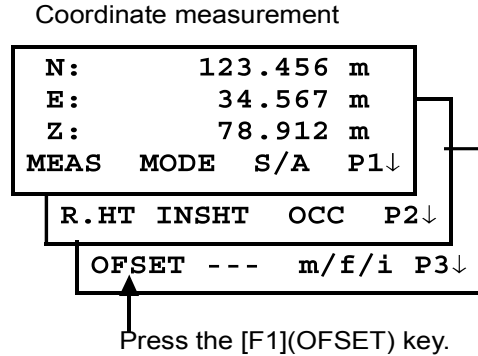
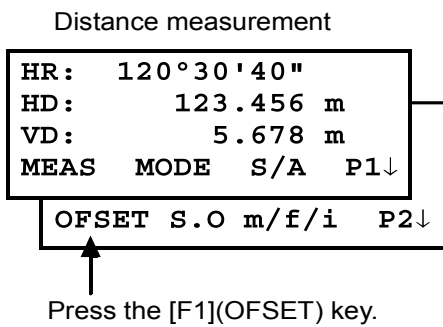

Offset Measurement Menu

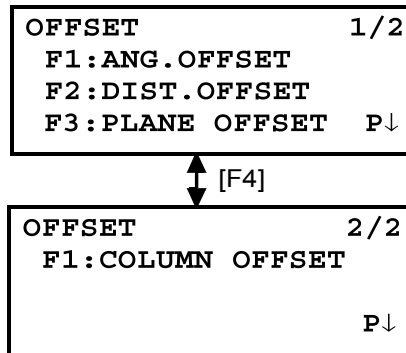

1 Outputting the Measurement Data

The results of offset measurement can be output to external device.

Setting the function of the [ESC] key to (REC), the [F3] soft key which assigned (REC) will appear in measured result display.

Refer to Chapter 16 "SELECTING MODE" to set this option.

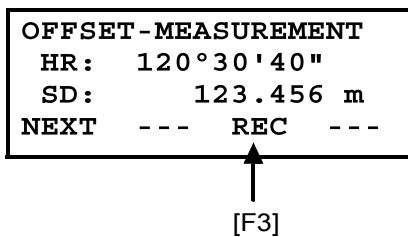

1 Distance measurement mode of the offset measurement

Offset measurement will be done by N-time fine measurement mode.

For setting measuring times refer to Chapter 16 "SELECTING MODE".

4.7.1 Angle Offset

This mode is useful when it is difficult to set up the prism directly, for example at the center of a tree. Place the prism at the same horizontal distance from the instrument as that of point A₀ to measure. To measure the coordinates of the center position, operate the offset measurement after setting the instrument height/prism height.

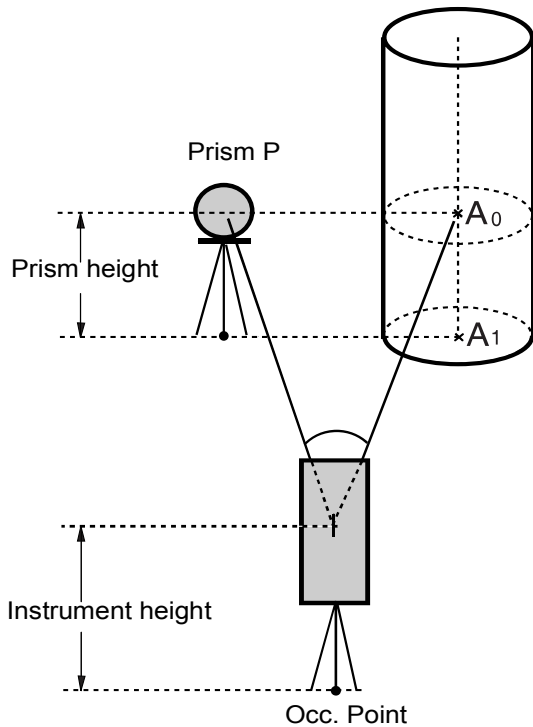

When measuring coordinates of ground point A₁ : Set the instrument height/prism height.

When measuring coordinates of point A₀ : Set the instrument height only. (Set the prism height to 0).

When sighting to A₀, you can select one of two ways. One is to fix vertical angle to the prism position even updown the telescope position, and the other is to gear vertical angle to the updown of telescope movement. In case following the vertical angle to the movement of telescope, SD(Slope Distance) and VD(Vertical Distance) will be changed according to the movement of telescope. To set this option, refer to Chapter 16 "SELECTING MODE".

- Set the instrument height/prism height before proceeding to the offset measurement mode.
- When setting the coordinate value for the occupied station, refer to Section 5.1 "Setting Coordinate Values of Occupied Point"..

Operating procedure	Operation	Display
1 Press the [F4](P1↓) key from distance measuring mode to get the function on page 2.	[F4]	<pre> HR: 120°30'40" HD: 123.456 m VD: 5.678 m MEAS MODE S/A P1↓ OFFSET S.O m/f/i P2↓ </pre>
2 Press the [F1](OFFSET) key.	[F1]	<pre> OFFSET 1/2 F1:ANG.OFFSET F2:DIST.OFFSET F3:PLANE OFFSET P1↓ </pre>
3 Press the [F1](ANG. OFFSET) key.	[F1]	<pre> OFFSET-MEASUREMENT HR: 120°30'40" HD: m MEAS --- --- --- </pre>
4 Collimate prism P, and press the [F1](MEAS) key.	Collimate P [F1]	<pre> OFFSET-MEASUREMENT HR: 110°20'30" HD* [n] << m >Measuring... </pre> <p style="text-align: center;">↓</p>

The horizontal distance from the instrument to the prism will be measured.

After measuring, the result added offset value will be shown.

5 Collimate point A₀ using the horizontal motion clamp and horizontal tangent screw.

Collimate
A₀

```

OFFSET-MEASUREMENT
HR: 110°20'30"
HD* 56.789 m
>Measuring...
    
```

6 Show the relative elevation of point A₀.

[]

```

OFFSET-MEASUREMENT
HR: 110°20'30"
HD: 56.789 m
NEXT --- --- ---
    
```

7 Show the slope distance of point A₀.

[]

Each time pressing the [] key, horizontal distance, relative elevation and slope distance are shown in sequence.

```

OFFSET-MEASUREMENT
HR: 113°20'30"
VD: 3.456 m
NEXT --- --- ---
    
```

8 Show N coordinate of point A₀ or A₁.

[]

Each time pressing [] key, N,E and Z coordinate are shown in sequence.

```

OFFSET-MEASUREMENT
HR: 113°20'30"
SD: 56.894 m
NEXT --- --- ---
    
```

```

OFFSET-MEASUREMENT
HR: 113°20'30"
N : -12.345 m
NEXT --- --- ---
    
```

To return to procedure **4**, press [F1](NEXT) key.
To return to the previous mode, press [ESC] key.

4.7.2 Distance Offset Measurement

The measurement of a place apart from a prism is possible by inputting offset horizontal distance of front and back / right and left.

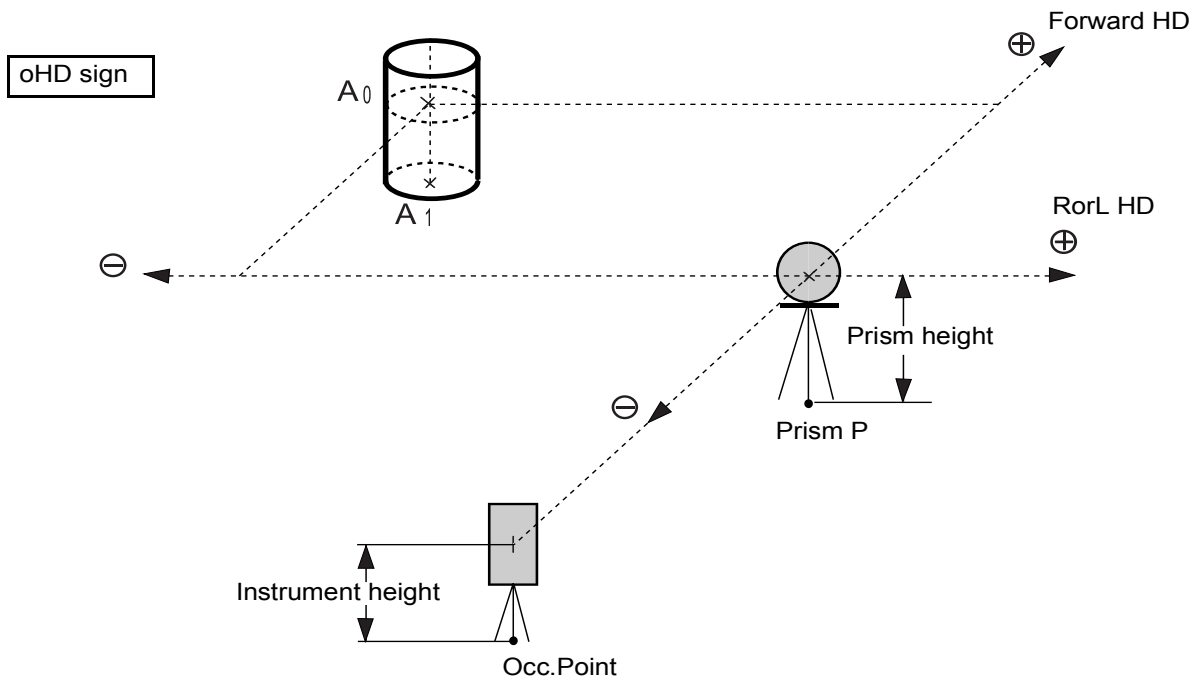

When measuring coordinates of ground point A₁: Set the instrument height / prism height.

When measuring coordinates of point A₀: Set the instrument height only.
(Set the prism height to 0).

Operating procedure	Operation	Display
1 Press the [F4](P1↓) key from distance measuring mode to get the function on page 2.	[F4]	<pre> HR: 120°30'40" HD: 123.456 m VD: 5.678 m MEAS MODE S/A P1↓ OFFSET S.O m/f/i P2↓ </pre>
2 Press the [F1](OFFSET) key.	[F1]	<pre> OFFSET 1/2 F1:ANG.OFFSET F2:DIST.OFFSET F3:PLANE OFFSET P↓ </pre>
3 Press the [F2](DIST. OFFSET) key.	[F2]	<pre> DISTANCE OFFSET INPUT RorL HD oHD= m --- --- [CLR] [ENT] </pre>
4 Enter Right and Left direction offset value, and press the [F4](ENTER) key.	Enter HD [F4]	<pre> DISTANCE OFFSET INPUT FORWARD HD oHD= m --- --- [CLR] [ENT] </pre>
5 Enter a Forward direction offset value, and press the [F4](ENTER) key.	Enter HD [F4]	<pre> DISTANCE OFFSET HR: 80°30'40" HD: m MEAS --- --- --- </pre>

6 Collimate prism P, and press the [F1](MEAS) key. Measuring will start.

Collimate P
[F1]

```
DISTANCE OFFSET
HR: 80°30'40"
HD* [n] << m
>Measuring...
```

After measuring, the result added offset value will be shown.



```
DISTANCE OFFSET
HR: 80°30'40"
HD* 10.000 m
NEXT --- --- ---
```

7 Show the relative elevation of point P0. Each time pressing the [] key, horizontal distance, relative elevation and slope distance are shown in sequence.

[]

```
DISTANCE OFFSET
HR: 80°30'40"
VD: 11.789 m
NEXT --- --- ---
```

Show coordinate of point P0.

[]

```
DISTANCE OFFSET
HR: 80°30'40"
SD: 11.789 m
NEXT --- --- ---
```

```
N : 12.345 m
E : 23.345 m
Z : 1.345 m
NEXT --- --- ---
```

To return to procedure **4**, press [F1](NEXT) key.
To return to the previous mode, press [ESC] key.

4.7.3 Plane Offset Measurement

Measuring will be taken for the place where direct measuring can not be done, for example distance or coordinate measuring for a edge of a plane.

Three random prism points (P1, P2, P3) on a plane will be measured at first in the plane offset measurement to determine the measured plane. Collimate the measuring target point (P0) then the instrument calculates and displays coordinate and distance value of cross point between collimation axis and of the plane.

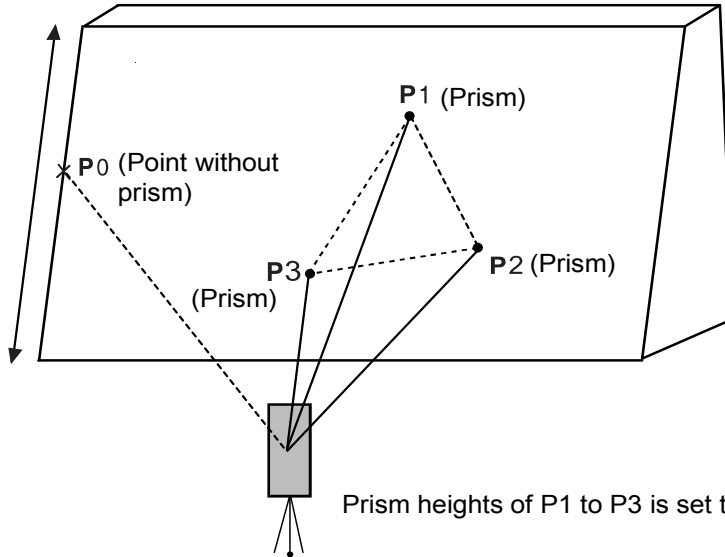



•When setting the coordinate value for the occupied station, refer to Section 5.1 “Setting Coordinate Values of Occupied Point” .

Operating procedure	Operation	Display
1 Press the [F4](P1↓) key from distance measuring mode to get the function on page 2.	[F4]	<pre> HR: 120°30'40" HD: 123.456 m VD: 5.678 m MEAS MODE S/A P1↓ OFFSET S.O m/f/i P2↓ </pre>
2 Press the [F1](OFFSET) key.	[F1]	<pre> OFFSET 1/2 F1:ANG.OFFSET F2:DIST.OFFSET F3:PLANE OFFSET P↓ </pre>
3 Press the [F3](PLANE OFFSET) key.	[F3]	<pre> PLANE N001#: SD: m MEAS --- --- --- </pre>
4 Collimate prism P1, and press the [F1](MEAS) key. N-time measuring will start. After measuring, the display will show the second point measurement.	Collimate P1 [F1]	<pre> PLANE N001#: SD* [n] << m >Measuring... </pre> <p style="text-align: center;">↓</p>
5 Measure the second and third points in the same way.	Collimate P2 [F1]	<pre> PLANE N002#: SD: m MEAS --- --- --- </pre> <p style="text-align: center;">↓</p>

The instrument calculates and displays coordinate and distance value of cross point between collimation axis and of the plane. *1),2)

6 Collimate the edge (P0) of the plane. *3),4)

7 To show the slope distance (SD), press the [] key.

Each time pressing the [] key, horizontal distance, relative elevation and slope distance are shown in sequence.

To show coordinate of point P0, press the [] key.

8 To escape the measuring, press the [F1](EXIT) key. The display returns to the previous mode.

Collimate
P3
[F1]

```

PLANE
N003#:
SD:          m
MEAS  ---  ---  ---
    
```



```

HR:   80°30'40"
HD:   54.321 m
VD:   10.000 m
EXIT
    
```

Collimate
P0

```

HR:   75°30'40"
HD:   54.600 m
VD:   -0.487 m
EXIT
    
```

```

V :    90°30'40"
HR:   75°30'40"
SD:   56.602 m
EXIT
    
```

*1) In case the calculation of plane was not successful by the measured three points, error displays. Start measuring over again from the first point.
 *2) Data display is the mode beforehand of offset measurement mode.
 *3) Error will be displayed when collimated to the direction which does not cross with the determined plane.
 *4) The refractor height of the target point P0 is set to zero automatically.

4.7.4 Column Offset Measurement

If it is possible to measure circumscription point (P1) of column directly, the distance to the center of the column (P0), coordinate and direction angle can be calculated by measured circumscription points (P2) and (P3).

The direction angle of the center of the column is 1/2 of total direction angle of circumscription points (P2) and (P3).

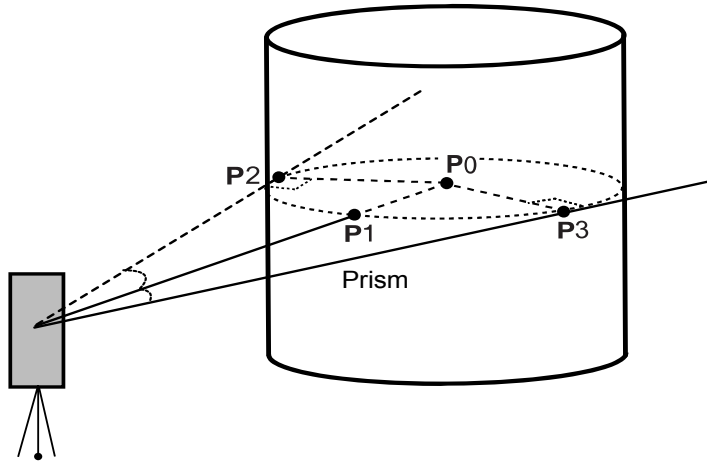

•When setting the coordinate value for the occupied station, refer to Section 5.1 “Setting Coordinate Values of Occupied Point” .

Operating procedure	Operation	Display
1 Press the [F4](P1↓) key from distance measuring mode to get the function on page 2.	[F4]	<pre> HR: 120°30'40" HD: 123.456 m VD: 5.678 m MEAS MODE S/A P1↓ OFFSET S.O m/f/i P2↓ </pre>
2 Press the [F1](OFFSET) key.	[F1]	<pre> OFFSET 1/2 F1:ANG.OFFSET F2:DIST.OFFSET F3:PLANE OFFSET P↓ </pre>
3 Press the [F4](P↓) key.	[F4]	<pre> OFFSET 2/2 F1:COLUMN OFFSET P↓ </pre>
4 Press the [F1](COLUMN OFFSET) key.	[F1]	<pre> COLUMN OFFSET Center HD: m MEAS --- --- --- </pre>
5 Collimate the center of the column (P1) and press the [F1](MEAS) key. N-time measuring will start.	Collimate P1 [F1]	<pre> COLUMN OFFSET Center HD* [n] << m >Measuring... ↓ </pre>

After the measurement, angle measuring display of the left side (P2) will be shown.

- 6 Collimate the left side of the column (P2) and press the [F4](SET) key. After the measurement, angle measuring display of the right side (P3) will be shown.

- 7 Collimate the right side of the column (P3) and press the [F4](SET) key.

The distance between the instrument and center of the column (P0) will be calculated.

- 8 To show the relative elevation (VD), press the [] key.

Each time pressing the [] key, horizontal distance, relative elevation and slope distance are shown in sequence.

To show coordinate of point P0, press the [] key.

- 9 To escape the measuring, press the [ESC] key. The display returns to the previous mode.

Collimate
P2
[F4]

Collimate
P3
[F4]

[]

```

COLUMN OFFSET
Left
HR: 120°30'40"
--- --- --- SET
    
```



```

COLUMN OFFSET
Right
HR: 180°30'40"
--- --- --- SET
    
```



```

COLUMN OFFSET
HR: 150°30'40"
HD: 43.321 m
NEXT --- --- ---
    
```

```

COLUMN OFFSET
HR: 150°30'40"
VD: 2.321 m
NEXT --- --- ---
    
```

5 COORDINATE MEASUREMENT

5.1 Setting Coordinate Values of Occupied Point

Set the coordinates of the instrument (occupied point) according to coordinate origin, and the instrument automatically converts and displays the unknown point (prism point) coordinates following the origin.

It is possible to retain the coordinates of the occupied point after turning the power off. Refer to Chapter 16 "SELECTING MODE".

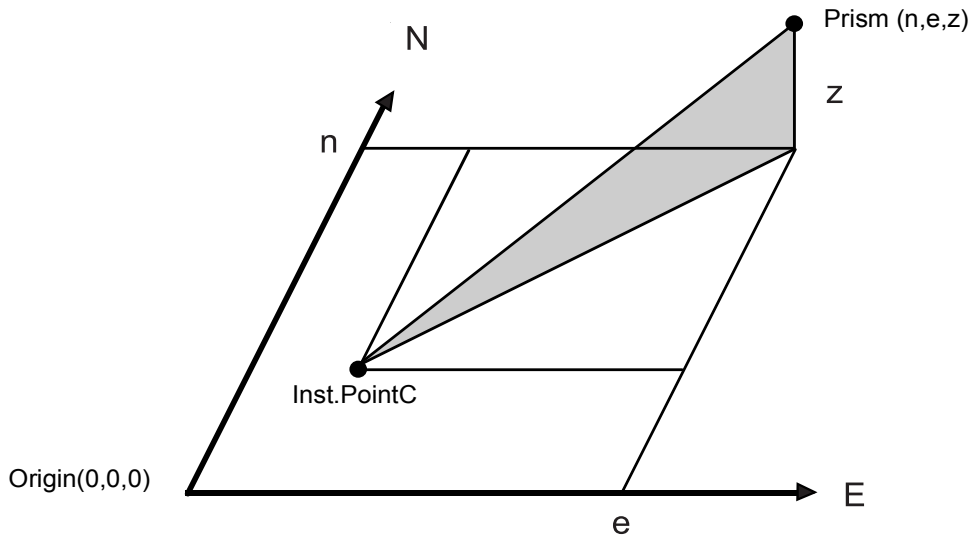

Operating procedure	Operation	Display
1 Press the [F4](↓) key from the coordinate measurement mode to get the function on page 2.	[F4]	<pre> N: 123.456 m E: 34.567 m Z: 78.912 m MEAS MODE S/A P1↓ R.HT INSHT OCC P2↓ </pre>
2 Press the [F3](OCC) key.	[F3]	<pre> N= 0.000 m E: 0.000 m Z: 0.000 m --- --- [CLR] [ENT] </pre>
3 Enter N coordinate value. *1)	Enter data [F4]	<pre> N: -72.000 m E= 0.000 m Z: 0.000 m --- --- [CLR] [ENT] </pre>
4 Enter E and Z coordinate values in the same manner. After entering the values, the display returns coordinate measuring display.		<pre> N: 51.456 m E: 34.567 m Z: 78.912 m MEAS MODE S/A P1↓ </pre>
*1) Refer to Section 2.5 "How to Enter Alphanumeric characters". •Input range $-9999999.9990 \leq N,E,Z \leq +99999999.9990\text{m}$ $-9999999.999 \leq N,E,Z \leq +99999999.999 \text{ ft.}$ $-9999999.11.7 \leq N,E,Z \leq +99999999.11.7 \text{ ft.+inch}$		

5.2 Setting Height of the Instrument

It is possible to retain the height of instrument after turning the power off. Refer to Chapter 16 "SELECTING MODE".

Operating procedure	Operation	Display
1 Press the [F4](↓) key from the coordinate measurement mode to get the function on page 2.	[F4]	<pre> N: 123.456 m E: 34.567 m Z: 78.912 m MEAS MODE S/A P1↓ R.HT INSHT OCC P2↓ </pre>
2 Press the [F2](INSHT) key. The current value is displayed.	[F2]	<pre> INSTRUMENT HEIGHT INPUT INS.HT= 0.000 m --- --- [CLR] [ENT] </pre>
3 Enter the instrument height. *1)	Enter Inst.HT [F4]	<pre> N: 123.456 m E: 34.567 m Z: 78.912 m MEAS MODE S/A P1↓ </pre>
<p>*1) Refer to Section 2.5 "How to Enter Alphanumeric characters". •Input range $-999.9999 \leq \text{Instrument height} \leq +999.9999 \text{ m}$ $-999.999 \leq \text{Instrument height} \leq +999.999 \text{ ft.}$ $-999.11.7 \leq \text{Instrument height} \leq +999.11.7 \text{ ft.+inch}$</p>		

5.3 Setting Height of Target (Prism Height)

This mode can be used to obtain Z coordinate values . It is possible to retain the height of target after turning the power off. Refer to Chapter 16 "SELECTING MODE".

Operating procedure	Operation	Display
1 Press the [F4](↓) key from the coordinate measurement mode to get the function on page 2.	[F4]	<pre> N: 123.456 m E: 34.567 m Z: 78.912 m MEAS MODE S/A P1↓ R.HT INSHT OCC P2↓ </pre>
2 Press the [F1](R.HT) key. The current value is displayed.	[F1]	<pre> REFLECTOR HEIGHT INPUT R.HT= 0.000 m --- --- [CLR] [ENT] </pre>
3 Enter the prism height. *1)	Enter R.HT [F4]	<pre> N: 123.456 m E: 34.567 m Z: 78.912 m MEAS MODE S/A P1↓ </pre>
<p>*1) Refer to Section 2.5 "How to Enter Alphanumeric characters". •Input range $-999.9999 \leq \text{Prism height} \leq +999.9999 \text{ m}$ $-999.999 \leq \text{Prism height} \leq +999.999 \text{ ft.}$ $-999.11.7 \leq \text{Prism height} \leq +999.11.7 \text{ ft.+inch}$</p>		

5.4 Execution of Coordinate Measuring

Measure the coordinates by entering the instrument height and prism height, coordinates of unknown point will be measured directly.

- When setting coordinate values of occupied point, see Section 5.1 “Setting Coordinate Values of Occupied Point”
- When setting the instrument height and prism height, see Section 5.2 “Setting Height of the Instrument” and 5.3 “Setting Height of Target (Prism Height)”.
- The coordinates of the unknown point are calculated as shown below and displayed:

Coordinates of occupied point : (N_0, E_0, Z_0)
 Instrument height : INS.HT
 Prism height : R.HT
 Vertical distance (Relative elevation) : z (VD)
 Coordinates of the center of the prism,
 originated from the center point of the instrument : (n, e, z)
 Coordinates of unknown point : (N_1, E_1, Z_1)
 $N_1 = N_0 + n$
 $E_1 = E_0 + e$
 $Z_1 = Z_0 + \text{INS.HT} + z - \text{R.HT}$

Coordinates of the center of the prism, originated from the center point of the instrument (n, e, z)

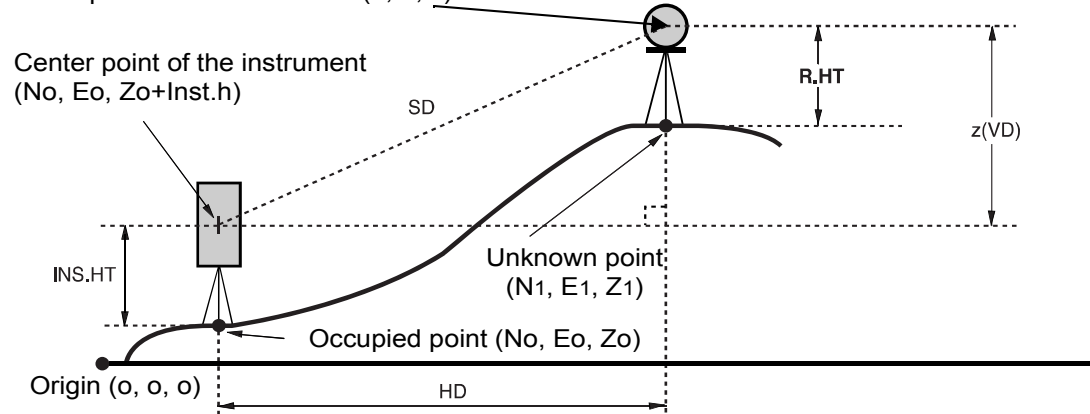

Operating procedure	Operation	Display
1 Set the direction angle of known point A. *1)	Set direction angle	V : 90°10'20" HR: 120°30'40"
2 Collimate target prism.	Collimate P	0SET HOLD HSET P1↓
3 Press the [↖] key. Measuring starts.	[↖]	N* [r] << m E: m Z: m MEAS MODE S/A P1↓
The result will be shown.		↓ N* 123.456 m E: 34.567 m Z: 78.912 m MEAS MODE S/A P1↓

- *1) Refer to Section 3.3 “Measuring from the Required Horizontal Angle”.
- In case the coordinate of instrument point is not entered, (0,0,0) will be used as the default for the instrument point.
- The instrument height will be calculated as 0 when the instrument height is not entered.
- The prism height will be calculated as 0 when the prism height is not set.

6 SPECIAL MODE (Menu Mode)

By pressing the [MENU] key, the instrument will be in MENU mode.
 In this mode, special measuring, setting and adjustment are possible.

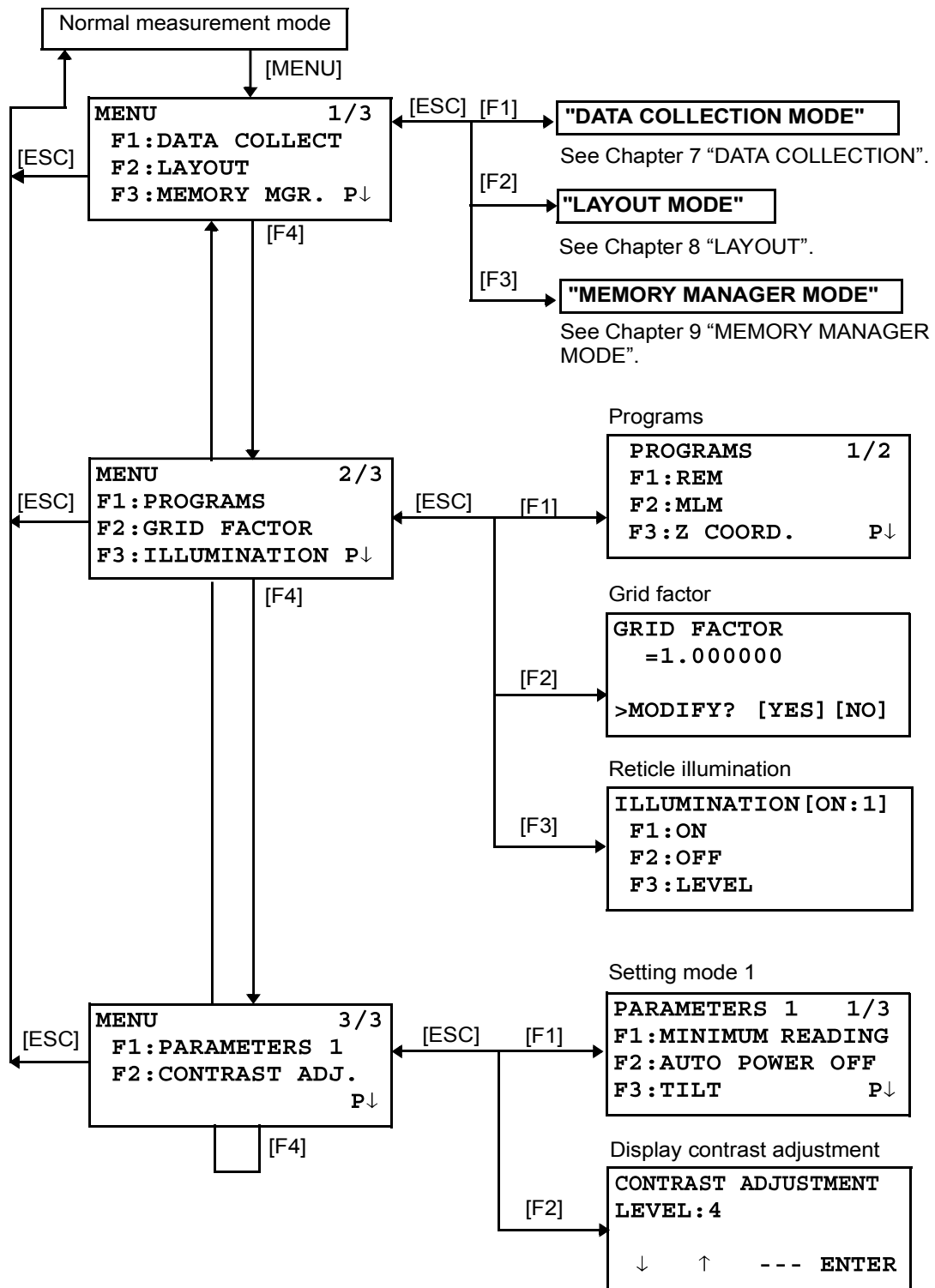

6.1 Application Measurement (PROGRAMS)

6.1.1 Remote Elevation measurement (REM)

To obtain elevation of the point at which setting the target prism is not possible, place the prism at any point on the vertical line from the target then carry out REM procedure as follows.

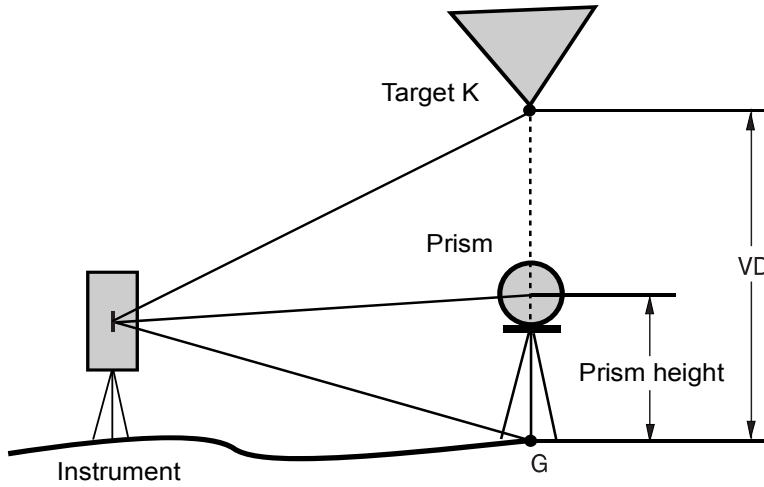

1) With prism height (h) input (Example :h=1.5m)

Operating procedure	Operation	Display
1 After pressing the [MENU] key, press the [F4](P↓) key to get the menu on page 2.	[MENU] [F4]	MENU 2/3 F1: PROGRAMS F2: GRID FACTOR F3: ILLUMINATION P↓
2 Press the [F1] key.	[F1]	PROGRAMS 1/2 F1: REM F2: MLM F3: Z COORD. P↓
3 Press the [F1](REM) key.	[F1]	REM F1: INPUT R.HT F2: NO R.HT
4 Press the [F1] key.	[F1]	REM-1 <STEP-1> R.HT = 0.000 m --- [CLR] [ENT]
5 Enter prism height. *1)	Enter R.HT [F4]	REM-1 <STEP-2> HD: m MEAS --- SET
6 Collimate prism.	Collimate P	
7 Press the [F1](MEAS) key. Measuring starts.	[F1]	REM-1 <STEP-2> HD* [n] << m >Measuring...



<p>Horizontal distance (HD) between the instrument and prism will be shown.</p> <p>8 After measuring, the prism position will be decided. *2)</p> <p>9 Collimate target K. Vertical distance (VD) will be shown. *3)</p>	<p>Collimate K</p>	<div style="border: 1px solid black; padding: 5px; margin-bottom: 5px;"> <p>REM-1 <STEP-2> HD* 123.456 m >Measuring...</p> </div> <div style="border: 1px solid black; padding: 5px; margin-bottom: 5px;"> <p>REM-1 VD: 1.500 m --- R.HT HD ---</p> </div> <div style="border: 1px solid black; padding: 5px;"> <p>REM-1 VD: 10.456 m --- R.HT HD ---</p> </div>
<p>*1) Refer to Section 2.5 "How to Enter Alphanumeric characters". *2) To return to procedure 5, press the [F2](R.HT) key. To return to procedure 6, press the [F3](HD) key. *3) To return to PROGRAMS Menu, press the [ESC] key.</p>		

2) Without prism height input

Operating procedure	Operation	Display
<p>1 After pressing the [MENU] key, press the [F4](P↓) key to get the menu on page 2.</p>	<p>[MENU] [F4]</p>	<div style="border: 1px solid black; padding: 5px;"> <p>MENU 2/3 F1:PROGRAMS F2:GRID FACTOR F3:ILLUMINATION P↓</p> </div>
<p>2 Press the [F1] key.</p>	<p>[F1]</p>	<div style="border: 1px solid black; padding: 5px;"> <p>PROGRAMS 1/2 F1:REM F2:MLM F3:Z COORD. P↓</p> </div>
<p>3 Press the [F1](REM) key.</p>	<p>[F1]</p>	<div style="border: 1px solid black; padding: 5px;"> <p>REM F1:INPUT R.HT F2:NO R.HT</p> </div>
<p>4 Press the [F2] key.</p>	<p>[F2]</p>	<div style="border: 1px solid black; padding: 5px;"> <p>REM-2 <STEP-1> HD: m MEAS --- --- ---</p> </div>
<p>5 Collimate prism.</p> <p>6 Press the [F1](MEAS) key. Measuring starts.</p>	<p>Collimate P [F1]</p>	<div style="border: 1px solid black; padding: 5px;"> <p>REM-2 <STEP-1> HD* [n] << m >Measuring...</p> </div>
<p>Horizontal distance (HD) between the instrument and prism will be shown.</p>		<div style="border: 1px solid black; padding: 5px;"> <p style="text-align: center;">↓</p> <div style="border: 1px solid black; padding: 5px;"> <p>REM-2 <STEP-1> HD* 123.456 m >Measuring...</p> </div> </div>

<p>7 After measuring, the prism position will be decided.</p>		<pre> REM-2 <STEP-2> V : 60°45'50" --- --- --- SET </pre>
<p>8 Collimate ground point G.</p>	Collimate G	<pre> REM-2 <STEP-2> V : 123°45'50" --- --- --- SET </pre>
<p>9 Press the [F4](SET) key. The position of point G will be decided. *1)</p>	[F4]	<pre> REM-2 VD: 0.000 m --- V HD --- </pre>
<p>10 Collimate target K. Vertical distance (VD) will be shown. *2)</p>	Collimate K	<pre> REM-2 VD: 10.456 m --- V HD --- </pre>
<p>*1) To return to procedure 5, press the [F3](HD) key. To return to procedure 8, press the [F2](V) key. *2) To return to PROGRAMS Menu, press the [ESC] key.</p>		

6.1.2 Missing Line Measurement (MLM)

Measurement for horizontal distance (dHD), slope distance (dSD), elevation (dVD) and horizontal bearing (HR) between two target prisms.

It is possible to enter the coordinate value directly or calculate from coordinate data file.

MLM mode has two modes.

1. MLM-1 (A-B, A-C) : Measurement is A-B, A-C, A-D,.....
2. MLM-2 (A-B, B-C) : Measurement is A-B, B-C, C-D,.....

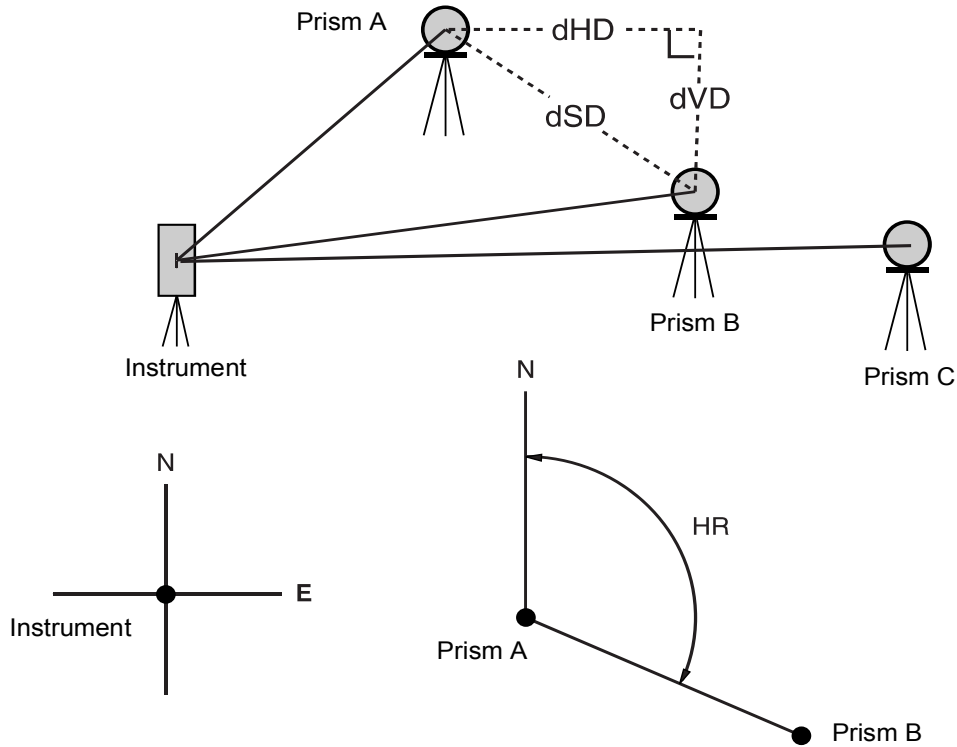



•It is necessary to set the direction angle of the instrument.

[Example] MLM-1 (A-B, A-C)

•Procedure of MLM-2 (A-B, B-C) mode is completely same as MLM-1 mode

Operating procedure	Operation	Display
1 After pressing the [MENU] key, press the [F4](P↓) key to get the menu on page 2.	[MENU] [F4]	MENU 2 / 3 F1: PROGRAMS F2: GRID FACTOR F3: ILLUMINATION P↓
2 Press the [F1] key.	[F1]	PROGRAMS 1 / 2 F1: REM F2: MLM F3: Z COORD. P↓
3 Press the [F2](MLM) key.	[F2]	MLM F1: USE FILE F2: DON'T USE
4 Press the [F1] or [F2] key to select using coordinate file. [Example: F2 : DON'T USE]	[F2]	GRID FACTOR F1: USE G.F. F2: DON'T USE

<p>5 Press the [F1] or [F2] key to select using GRID FACTOR. [Example:F2 : DON'T USE]</p>	<p>[F2]</p>	<pre>MLM F1:MLM-1 (A-B, A-C) F2:MLM-2 (A-B, B-C)</pre>
<p>6 Press the [F1] key.</p>	<p>[F1]</p>	<pre>MLM-1 (A-B, A-C) <STEP-1> HD: m MEAS R.HT NEZ ---</pre>
<p>7 Collimate prism A, and press the [F1](MEAS) key. Horizontal distance (HD) between the instrument and prism A will be shown.</p>	<p>Collimate A [F1]</p>	<pre>MLM-1 (A-B, A-C) <STEP-1> HD* [n] << m >Measuring...</pre>
<p>8 After measuring, the prism position will be decided.</p>		<p style="text-align: center;">↓</p> <pre>MLM-1 (A-B, A-C) <STEP-2> HD: m MEAS R.HT NEZ ---</pre>
<p>9 Collimate prism B and press the [F1](MEAS) key. Horizontal distance (HD) between the instrument and prism B will be shown.</p>	<p>Collimate B [F1]</p>	<pre>MLM-1 (A-B, A-C) <STEP-2> HD* [n] << m MEAS R.HT NEZ ---</pre>
<p>10 After measuring, the horizontal distance (dHD) and relative elevation (dVD) between prism A and B will be shown.</p>	<p>[F4]</p>	<p style="text-align: center;">↓</p> <pre>MLM-1 (A-B, A-C) dHD : 123.456 m dVD : 12.345 m --- --- HD ---</pre>
<p>11 To show slope distance (dSD) , press [] key.</p>	<p>[]</p>	<pre>MLM-1 (A-B, A-C) dSD : 234.567 m HR : 12°34'40" --- --- HD ---</pre>
<p>12 To measure the distance between points A and C, press the [F3](HD). *1)</p>	<p>[F3]</p>	<pre>MLM-1 (A-B, A-C) <STEP-2> HD: m MEAS R.HT NEZ ---</pre>
<p>13 Collimate point C (Prism C) and press the [F1](MEAS) key. Horizontal distance (HD) between the instrument and prism C will be shown.</p>	<p>Collimate prism C [F1]</p>	<p style="text-align: center;">⋮</p>
<p>14 After measuring, the horizontal distance (dHD) and relative elevation (dVD) between prism A and C will be shown.</p>	<p>[F4]</p>	<pre>MLM-1 (A-B, A-C) dHD : 234.567 m dVD : 23.456 m --- --- HD ---</pre>
<p>15 To measure the distance between points A and D, repeat procedure 12 to14. *1)</p>		
<p>*1) To return to previous mode, press the [ESC] key.</p>		

•How to use coordinate data

It is possible to input coordinate value directly or calculate from coordinate data file

Operating procedure	Operation	Display
<p>To use coordinate data file, select “USE FILE” in step 4.</p> <p>After procedure 6.</p> <p>1 Press the [F3](NEZ) key. Direct key input display will be shown.</p> <p>2 Press the [F3](PT#) key to use coordinate data file. Point number input display will be shown. Pressing the [F3](HD) key, the display will return to procedure 6.</p> <p>After selecting coordinate input mode by pressing the [F3](NEZ or PT# or HD) key, press the [F1](INPUT) key and enter the data.</p>	<p>[F3]</p> <p>[F3]</p>	<div style="border: 1px solid black; padding: 5px; margin-bottom: 5px;"> <p>MLM-1 (A-B, A-C) <STEP-1> HD: m MEAS R.HT NEZ ---</p> </div> <div style="border: 1px solid black; padding: 5px; margin-bottom: 5px;"> <p>N> 0.000 m E: 0.000 m Z: 0.000 m INPUT --- PT# ENTER</p> </div> <div style="border: 1px solid black; padding: 5px;"> <p>MLM-1 (A-B, A-C) PT#: _____ INPUT LIST HD ENTER</p> </div>

6.1.3 Setting Z Coordinate of Occupied Point

Occupied point coordinate data and known point actual measuring data are utilized, z coordinate of occupied point is calculated and reset again.

Known point data and coordinate data can use the coordinate data file.

1) Setting occupied coordinate

[Example setting] Using coordinate data file.

Operating procedure	Operation	Display
1 After pressing [MENU] key, press [F4](P↓) key to get the menu on page 2.	[MENU] [F4]	MENU 2/3 F1:PROGRAMS F2:GRID FACTOR F3:ILLUMINATION P↓
2 Press the [F1] key.	[F1]	PROGRAMS 1/2 F1:REM F2:MLM F3:Z COORD. P↓
3 Press the [F3](Z COORD.) key.	[F3]	Z COORD.SETTING F1:USE FILE F2:DON'T USE
4 Press the [F1](USE FILE) key.	[F1]	SELECT A FILE FN: _____ INPUT LIST --- ENTER
5 Press the [F1](INPUT) key and enter the File Name.	[F1] Enter FN [F4]	Z COORD.SETTING F1:OCC.PT INPUT F2:REF.MEAS
6 Press the [F1] key.	[F1]	OCC.PT PT#: _____ INPUT LIST NEZ ENTER
7 Press the [F1](INPUT) key and enter the Point number. Instrument height setting display will be shown.	[F1] Enter PT# [F4]	INSTRUMENT HEIGHT INPUT INS.HT= 0.000 m --- --- [CLR] [ENT]
8 Enter the height. The display returns to Z coordinate menu.	Enter HT [F4]	Z COORD.SETTING F1:OCC.PT INPUT F2:REF.MEAS

•For more information about data file, see Chapter 9 “MEMORY MANAGER MODE” .

2) Z Coordinate Calculation from Known Point Measuring Data

[Example setting] Using coordinate data file

Operating procedure	Operation	Display
1 After pressing [MENU] key, press [F4](P↓) key to get the menu on page 2.	[MENU] [F4]	MENU 2/3 F1: PROGRAMS F2: GRID FACTOR F3: ILLUMINATION P↓
2 Press the [F1] key.	[F1]	PROGRAMS 1/2 F1: REM F2: MLM F3: Z COORD. P↓
3 Press the [F3](Z COORD.) key.	[F3]	Z COORD. SETTING F1: USE FILE F2: DON'T USE
4 Press the [F1](USE FILE) key.	[F1]	SELECT A FILE FN: _____ INPUT LIST --- ENTER
5 Press the [F1](INPUT) key and enter the File Name.	[F1] Enter FN [F4]	Z COORD. SETTING F1: OCC. PT INPUT F2: REF. MEAS
6 Press the [F2] key.	[F2]	NOO1# PT#: _____ INPUT LIST NEZ ENTER
7 Press the [F1](INPUT) key and enter the Point Number in coordinate data file.	[F1] Enter PT# [F4]	N: 4.356 m E: 16.283 m Z: 1.553 m >OK ? [YES] [NO]
8 Press the [F3](YES) key and enter the Point Number in coordinate data file.	[F3]	REFLECTOR HEIGHT INPUT R.HT= 0.000 m --- --- [CLR] [ENT]
9 Enter the height.	Enter R. HT [F4]	REFLECTOR HEIGHT INPUT R.HT: 0.000 m >Sight? [YES] [NO]
10 Collimate a prism on the point and press the [F3](YES) key. Measuring starts. *1)	Collimate P [F3]	HR: 120°30'40" HD* [n] << m VD: m >Measuring...

<p>11 Press the [F4](CALC) key.*2) Z : Z coordinate dZ: Standard deviation</p>	<p>[F4]</p>	<pre> HR: 120°30'40" HD: 12.345 m VD: 23.456 m NEXT --- --- CALC </pre>
<p>12 Press the [F4](SET) key. *3) Z coordinate of the occupied point will be set. Basksight point measuring screen will be shown.</p>	<p>[F4]</p>	<pre> Z COORD. SETTING Z : 1.234 m dZ : 0.002 m --- --- BS SET </pre>
<p>13 Press the [F3](YES) key. Horizontal angle will be set. The display returns to Programs 1/2 menu.</p>	<p>[F3]</p>	<pre> BACKSIGHT HR: 23°20'40" >OK? [YES] [NO] PROGRAMS 1/2 F1:REM F2:MLM F3:Z COORD. P↓ </pre>
<p>*1) Measurement is Fine N-times measurement mode. *2) To measure other points, press the [F1](NEXT) key. *3) Pressing the [F3] key, the display will be changed alternately.</p>		

6.1.4 Area Calculation

This mode calculate the area of a closed figure.
There are two area calculation methods as follows.

- 1) Area Calculation from Coordinate data file
- 2) Area Calculation from Measured data

- Area is not calculated correctly if enclosed lines cross each other.
- It is impossible to calculate what a mix of coordinate file data and measured data.
- If the coordinate data file does not exist, the area calculation from measured data is done automatically.
- The numbers of points used to calculate are not limited.

1) Area Calculation from Coordinate Data File

Operating procedure	Operation	Display
1 After pressing the [MENU] key, press the [F4](P↓) key to get the menu on page 2/3.	[MENU] [F4]	MENU 2/3 F1:PROGRAMS F2:GRID FACTOR F3:ILLUMINATION P↓
2 Press the [F1] key.	[F1]	PROGRAMS 1/2 F1:REM F2:MLM F3:Z COORD. P↓
3 Press the [F4](P↓) key to get the PROGRAMS menu on page 2/2.	[F4]	PROGRAMS 2/2 F1:AREA F2:POINT TO LINE P↓
4 Press the [F1](AREA) key.	[F1]	AREA F1:FILE DATA F2:MEASUREMENT
5 Press the [F1](FILE DATA) key.	[F1]	SELECT A FILE FN: _____ INPUT LIST --- ENTER
6 Press the [F1](INPUT) key and enter the File Name. Initial display will be shown.	[F1] Enter FN [F4]	AREA 0000 m.sq NEXT# :DATA-01 PT# LIST UNIT NEXT
7 Press the [F4](NEXT) key. *1),2) The top of the file data (DATA-01) will be set and the second point number will be shown.	[F4]	AREA 0001 m.sq NEXT# :DATA-02 PT# LIST UNIT NEXT
8 Repeat pressing the [F4](NEXT) key to set required number of points.	[F4]	⋮

When 3 or more points are set, the area surrounded by the points is calculated and the result will be shown.

```

AREA                0021
                   123.456 m.sq
NEXT# :DATA-22
PT#  LIST  UNIT  NEXT
    
```

- *1) To set specify point, press the [F1](PT#) key.
- *2) To show the list of the coordinate data in the file, press the [F2](LIST) key.

2) Area Calculation from Measured Data

Operating procedure	Operation	Display
1 After pressing the [MENU] key, press the [F4](P↓) key to get the menu on page 2/3.	[MENU] [F4]	<pre> MENU 2 / 3 F1:PROGRAMS F2:GRID FACTOR F3:ILLUMINATION P↓ </pre>
2 Press the [F1] key.	[F1]	<pre> PROGRAMS 1 / 2 F1:REM F2:MLM F3:Z COORD. P↓ </pre>
3 Press the [F4](P↓) key to get the PROGRAMS menu on page 2/2.	[F4]	<pre> PROGRAMS 2 / 2 F1:AREA F2:POINT TO LINE P↓ </pre>
4 Press the [F1](AREA) key.	[F1]	<pre> AREA F1:FILE DATA F2:MEASUREMENT </pre>
5 Press the [F2](MEASUREMENT) key.	[F2]	<pre> AREA F1:USE G.F. F2:DON'T USE </pre>
6 Press the [F1] or [F2] key to select using GRID FACTOR. [Example:F2 : DON'T USE]	[F2]	<pre> AREA 0000 m.sq MEAS --- UNIT --- </pre>
7 Collimate a prism and press the [F1](MEAS) key. Measuring starts. *1)	Collimate P [F1]	<pre> N* [n] <<< m E: m Z: m >Measuring... ↓ AREA 0001 m.sq MEAS --- UNIT --- </pre>
8 Collimate next point and press the [F1](MEAS) key.	Collimate [F1]	<p>.....</p>

When 3 or more points are measured, the area surrounded by the points is calculated and the result will be shown.

```

AREA          0003
      234.567 m.sq
MEAS  ---  UNIT  ---
    
```

*1) Measurement is Fine N-times measurement mode.

•To change the display unit

It is possible to change the displayed area unit.

Operating procedure	Operation	Display
<p>1 Press the [F3](UNIT) key.</p> <p>2 Select a unit by pressing the [F1] to [F4] key. Example: [F2](ha) key.</p>	[F3]	<pre> AREA 0003 100.000 m.sq MEAS --- UNIT --- </pre>
	[F2]	<pre> AREA 0003 100.000 m.sq m.sq ha ft.sq acre AREA 0003 0.010 ha MEAS --- UNIT --- </pre>
<p>•m.sq : square meter ha : hectare ft.sq : square feet acre : acre.</p>		

6.1.5 Point to Line Measurement

This mode is used to obtain the coordinate data with the origin point $A(0,0,0)$ and the line AB as N axis.

Place the 2 prisms at the points A and B on the line, and place the instrument at unknown point C. After measuring the 2 prisms, the coordinate data and the direction angle of the instrument will be calculated and restored.

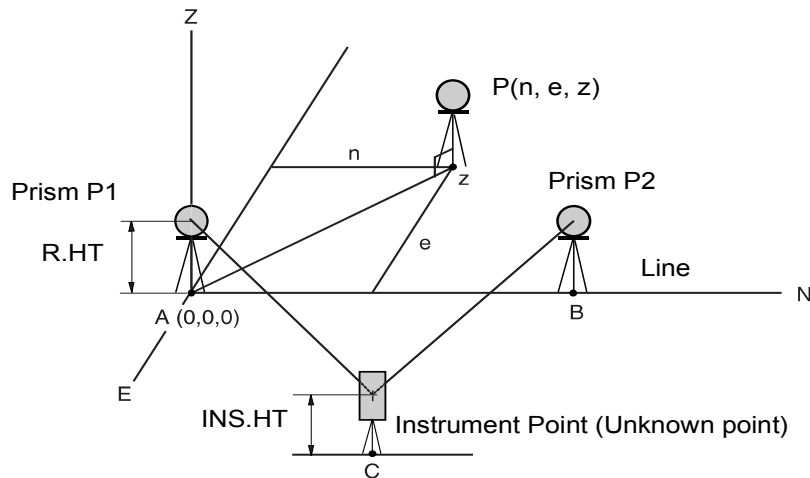

Operating procedure	Operation	Display
1 After pressing the [MENU] key, press the [F4](P↓) key to get the menu on page 2/3.	[MENU] [F4]	MENU 2/3 F1:PROGRAMS F2:GRID FACTOR F3:ILLUMINATION P↓
2 Press the [F1] key.	[F1]	PROGRAMS 1/2 F1:REM F2:MLM F3:Z COORD. P↓
3 Press the [F4](P↓) key to get the PROGRAMS menu on page 2/2.	[F4]	PROGRAMS 2/2 F1:AREA F2:POINT TO LINE P↓
4 Press the [F2] key.	[F2]	INSTRUMENT HEIGHT INPUT INS.HT= 0.000 m --- --- [CLR] [ENT]
5 Enter instrument height.	Enter INS.HT [F4]	REFLECTOR HEIGHT INPUT R.HT= 0.000 m --- --- [CLR] [ENT]
6 Enter reflector A(P1) height.	Enter R.HT [F4]	POINT TO LINE MEAS.P1 HD: m >Sight? [YES] [NO]

<p>7 Collimate prism P1 (Origin) and press [F3](YES) key. Measuring starts. *1)</p>	<p>Collimate P1 [F3]</p>	<pre>POINT TO LINE MEAS.P1 HD* [n] << m >Measuring...</pre>
<p>Input display of reflector B(P2) height will be shown.</p>		<pre>REFLECTOR HEIGHT INPUT R.HT= 0.000 m --- --- [CLR] [ENT]</pre>
<p>8 Enter reflector B(P2) height.</p>	<p>Enter R. HT [F4]</p>	<pre>POINT TO LINE MEAS.P2 HD: m >Sight? [YES] [NO]</pre>
<p>9 Collimate prism B (P2)(Origin) and press the [F3](YES) key. Measuring starts. *1)</p>	<p>Collimate P2 [F3]</p>	<pre>POINT TO LINE MEAS.P2 HD* [n] << m >Measuring...</pre>
<p>The coordinate data and the direction angle of the instrument are calculated and restored. The result (The distance between A and B) will be displayed. dHD: Horizontal distance dVD:Vertical distance dSD:Slope distance *2) ,3)</p>		<pre>DIST. (P1-P2) 1/2 dHD: 10.000 m dVD: 0.000 m NEZ S.CO --- P↓</pre>
<p>10 Press [F1](NEZ) key to measure other points.</p>	<p>[F1]</p>	<pre>N: 0.000 m E: 0.000 m Z: 0.000 m EXIT --- HT MEAS >Measuring...</pre>
<p>11 Collimate a prism and press [F4](MEAS) key. Coordinate measurement starts. *4) The result will be shown. *5)</p>	<p>Collimate P [F4]</p>	<pre>N: 3.456 m E: 5.432 m Z: 0.000 m EXIT --- HT MEAS</pre>
<p>*1) Measurement is Fine N-times measurement mode. *2) To show dSD, press [F4](P↓) key. *3) To show the new occupied data, press [F2](S.CO) key. *4) Measurement is Fine N-times measurement mode. *5) To return to previous mode, press [F1](EXIT) key.</p>		

6.2 Setting the GRID FACTOR

GRID FACTOR can reset in this menu mode.

For more information, refer to Section 8.1.1 "Setting the GRID FACTOR".

Grid Factor can be applied to the following application programs.

It is also possible to cancel the Grid factor function by selecting "DON'T USE" in "SELECTING MODE". At this time the setting and selecting screens for Grid Factor will be omitted.

• Data collection mode

When the NEZ automatic calculation (NEZ AUTO. CALC) is ON, Grid factor will be applied to the coordinate data (Including PTL data) recorded into a coordinate data file when the RAW data is measured and recorded. (In this case, Grid Factor is not applied to the RAW data recorded into the measured data file.)

•PTL (Point To Line measurement)

When executing PTL measurement mode, the NEZ Auto Calculation will be turned on compulsorily and Grid factor will be applied to the coordinate data.

•Layout

Execution Layout (Including PTL measurement mode)

1. When displaying the difference (dHD) between grid horizontal distance to a layout point (HDg) on the projection plane and measured ground horizontal distance to a prism point (HD), Grid factor will be applied to grid distance (HDg) in order to reverse-convert grid distance to ground distance.

2. After completion of a layout point, the displayed coordinate data will be applied to grid factor in order to compare with surveying data and calculated data on the projection plane.

(NEW POINT-Side Shot)

In side shot method, a new point coordinate data will be applied to grid factor and the new point coordinate data will be recorded into a coordinate data file.

(NEW POINT - Resection)

In resection method, when a new point calculated coordinate data is displayed or recorded, the new point coordinate data will be applied to grid factor and the coordinate data will be recorded into a coordinate data file.

•MLM (Missing Line Measurement)

When selecting grid factor "USE G.F.", measured data will be applied to grid factor. At this time, horizontal distance (dHD) and slope distance (dSD) will be on the projection plane.

•AREA (Area calculation / Measured method)

When selecting grid factor "USE G.F.", measured data will be applied to grid factor. At this time, the calculated area will be on the projection plane.

Note: Calculation of Z coordinate is not influenced even if it is applied to grid factor.

Operating procedure	Operation	Display
1 After pressing the [MENU] key, press the [F4](P↓) key to get the menu on page 2.	[MENU] [F4]	<pre> MENU 2 / 3 F1 : PROGRAMS F2 : GRID FACTOR F3 : ILLUMINATION P↓ </pre>
2 Press the [F2](GRID FACTOR) key.	[F2]	<pre> GRID FACTOR =0.998843 >MODIFY? [YES] [NO] </pre>

<p>3 Press the [F3](YES) key.</p> <p>4 Enter Elevation. *1) Press the [F4](ENT) key.</p> <p>5 Enter Scale Factor in the same way.</p> <p>Grid Factor is displayed for 1 to 2 second and display returns to menu.</p>	<p>[F3]</p> <p>Enter ELEV. [F4]</p> <p>Enter Scale [F4]</p>	<div style="border: 1px solid black; padding: 5px; margin-bottom: 5px;"> GRID FACTOR ELEV.=1000 m SCALE:0.999000 --- --- [CLR] [ENT] </div> <div style="border: 1px solid black; padding: 5px; margin-bottom: 5px;"> GRID FACTOR ELEV.:2000 m SCALE=1.001000 --- --- [CLR] [ENT] </div> <div style="border: 1px solid black; padding: 5px;"> GRID FACTOR =1.000686 </div>
<p>*1) Refer to Section 2.5 "How to Enter Alphanumeric characters".</p> <p>•Input Range :Elevation : -9,999 to +9,999 meter (-32,805 to +3,2805 ft, ft+in) Scale Factor: 0.990000 to 1.010000</p>		

6.3 Setting Illumination of Display and Cross Hairs

Setting ON/OFF/LEVEL (1 to 9) for illumination of display (LCD) and reticle.

•Setting LEVEL (1 to 9) is only for reticle.

[Example setting] LEVEL:2 and turn on the illumination.

Operating procedure	Operation	Display
<p>1 After pressing the [MENU] key, press the [F4](P↓) key to get the menu on page 2.</p>	<p>[MENU] [F4]</p>	<div style="border: 1px solid black; padding: 5px;"> MENU 2/3 F1:PROGRAMS F2:GRID FACTOR F3:ILLUMINATION P↓ </div>
<p>2 Press the [F3] key. The data previously set is shown.</p>	<p>[F3]</p>	<div style="border: 1px solid black; padding: 5px;"> ILLUMINATION [OFF:1] F1:ON F2:OFF F3:LEVEL </div>
<p>3 Press the [F3](LEVEL) key.</p>	<p>[F3]</p>	<div style="border: 1px solid black; padding: 5px;"> ILLUMINATION [OFF:1] [LEVEL MODE] ↓ ↑ --- ENTER </div>
<p>4 Press the [F2](↑) key, and then press the [F4](ENTER) key.</p>	<p>[F2] [F4]</p>	<div style="border: 1px solid black; padding: 5px;"> ILLUMINATION [OFF:2] F1:ON F2:OFF F3:LEVEL </div>
<p>5 Press the [F1](ON) key.</p>	<p>[F1]</p>	<div style="border: 1px solid black; padding: 5px;"> ILLUMINATION [ON:2] F1:ON F2:OFF F3:LEVEL </div>
<p>•To return to previous mode, press the [ESC] key.</p>		

6.4 Setting Mode 1

In this mode, the following settings are possible.

1. Setting Minimum Reading
 2. Auto Power off
 3. Vertical Angle Tilt Correction (Tilt ON/OFF)
 4. Heater ON/OFF
 5. Setting for RS-232C communication
- This setting is memorized after power off.

6.4.1 Setting Minimum Reading

Select minimum display unit for angle measurement, coarse distance measurement mode.

•To select minimum display for fine measurement mode, see Chapter 16 "SELECTING MODE" .

Angle Unit			Coarse mode Distance unit
Degree	GON	MIL	
5" / 1"	1mgon / 0.2mgon	0.1mil / 0.01mil	10mm (0.02ft)/ 1mm(0.005ft)

[Example] Minimum angle : 5", Coarse : 1mm

Operating procedure	Operation	Display
1 After pressing the [MENU] key, press the [F4](P↓) key twice to get the menu on page 3.	[MENU] [F4] [F4]	MENU 3/3 F1:PARAMETERS 1 F2:CONTRAST ADJ. P↓
2 Press the [F1] key.	[F1]	PARAMETERS 1 1/2 F1:MINIMUM READING F2:AUTO POWER OFF F3:TILT P↓
3 Press the [F1] key.	[F1]	MINIMUM READING F1:ANGLE F2:COARSE
4 Press the [F1] key.	[F1]	MINIMUM ANGLE [F1: 1"] F2: 5" ENTER
5 Press the [F2](5") key and press the [F4](ENTER) key.	[F2] [F4]	MINIMUM READING F1:ANGLE F2:COARSE
6 Press the [F2] key.	[F2]	COARSE READING F1: 1mm [F2: 10mm] ENTER
7 Press the [F1] key and press the [F4](ENTER) key.	[F1] [F4]	MINIMUM READING F1:ANGLE F2:COARSE

•To return to previous mode, press the [ESC] key.

6.4.2 Auto Power Off

If no key operation is given or no process of measurement is performed for more than 30 minutes (No change exceeding 30" has occurred during horizontal angle or vertical angle measurement.), the power turns off automatically. If the instrument is set at distance measurement mode (No change in distance exceeding 10cm has occurred during distance measurement), the mode changes to angle measurement automatically in case that the instrument does not operate for approximately 10 minutes, and the power turns off after 20 minutes.

Operating procedure	Operation	Display
1 After pressing the [MENU] key, press the [F4](P↓) key twice to get the menu on page 3.	[MENU] [F4] [F4]	MENU 3/3 F1:PARAMETERS 1 F2:CONTRAST ADJ. P↓
2 Press the [F1] key.	[F1]	PARAMETERS 1 1/3 F1:MINIMUM READING F2:AUTO POWER OFF F3:TILT P↓
3 Press the [F2] key. The data previously set is shown.	[F2]	AUTO POWER OFF [OFF] F1:ON F2:OFF ENTER
4 Press the [F1](ON) key or [F2](OFF) key, and press the [F4](ENTER) key.	[F1] or [F2] [F4]	

6.4.3 Vertical Angle Tilt correction (Tilt ON/OFF)

In case the instrument is used in an unstable situation, constant indexing of vertical and horizontal angle may be impossible. In this case, the function of tilt correction can be stopped by selecting TILT OFF. It has been set to X (V) TILT ON at the factory.

•This setting is memorized after powering off.

Operating procedure	Operation	Display
1 After pressing the [MENU] key, press the [F4](P↓) key twice to get the menu on page 3.	[MENU] [F4] [F4]	MENU 3/3 F1:PARAMETERS 1 F2:CONTRAST ADJ. P↓
2 Press the [F1] key.	[F1]	PARAMETERS 1 1/3 F1:MINIMUM READING F2:AUTO POWER OFF F3:TILT P↓
3 Press the [F3] key. The data previously set is shown. If already ON, the display shows tilt correction value.	[F3]	TILT SENSOR: [X-ON] X: 0°02'10" X-ON --- OFF ENTER
4 Press the [F1](X-ON) key or [F3](OFF) key, and press the [F4](ENTER) key.	[F1], [F3] [F4]	

6.4.4 Heater ON/OFF

The heater option for both display units can be turned OFF or ON.

Operating procedure	Operation	Display
1 After pressing the [MENU] key, press the [F4](P↓) key twice to get the menu on page 2.	[MENU] [F4] [F4]	<pre> MENU 3/3 F1:PARAMETERS 1 F2:CONTRAST ADJ. P↓ </pre>
2 Press the [F1] key.	[F1]	<pre> PARAMETERS 1 1/3 F1:MINIMUM READING F2:AUTO POWER OFF F3:TILT P↓ </pre>
3 Press the [F4] key.	[F4]	<pre> PARAMETERS 1 2/3 F1:BATTERY TYPE F2:HEATER F3:RS-232C P↓ </pre>
4 Press the [F2] key. The data previously set is shown.	[F2]	<pre> HEATER [OFF] F1:ON F2:OFF ENTER </pre>
5 Press the [F1](ON) key or [F2](OFF) key, and press the [F4](ENTER) key.	[F1] or [F2] [F4]	

6.4.5 Setting RS-232C communication with external device

You can set the parameters for RS-232C communication with external device from parameters setting menu .

The following parameters can be set.

Item	Selecting items
Baud rate	1200, 2400, 4800, 9600, 19200, 38400
Character bit/Parity	7/Even, 7/Odd, 8/None
Stop bit	1, 2
ACK mode	Standard , Omitted
CR,LF	ON, OFF
REC type	REC-A, REC-B
Factory setting	Baud rate:1200 baud, Character bit/Parity:7/Even, CRLF:OFF, REC type: REC-A, ACK:Standard

ACK mode, CRLF and REC type are interlocked with the same items in the selecting mode. Refer to 16 "SELECTING MODE".

Sample setting STOP BITS: 2

Operating procedure	Operation	Display
1 After pressing the [MENU] key, press the [F4](P↓) key twice to get the menu on page 2.	[MENU] [F4] [F4]	MENU 3/3 F1:PARAMETERS 1 F2:CONTRAST ADJ. P↓
2 Press the [F1] key.	[F1]	PARAMETERS 1 1/2 F1:MINIMUM READING F2:AUTO POWER OFF F3:TILT P↓
3 Press the [F4] key.	[F4]	PARAMETERS 1 2/2 F1:BATTERY TYPE F2:HEATER F3:RS-232C P↓
4 Press the [F3] key. The data previously set is shown.	[F3]	RS-232C 1/3 F1:BAUD RATE F2:CHAR./PARITY F3:STOP BITS P↓
5 Press the [F3] key to select STOP BITS. The data previously set is marked.	[F3]	STOP BITS [F1:1] F2:2 ENTER
6 Press the [F2](2) key to select stop bit 2, and press the [F4](ENTER) key.	[F2] [F4]	STOP BITS F1:1 [F2:2] ENTER

6.5 Setting Contrast of Display

Setting level for contrast of display (LCD)

Operating procedure	Operation	Display
1 After pressing the [MENU] key, press the [F4](P↓) key twice to get the menu on page 3.	[MENU] [F4] [F4]	<div style="border: 1px solid black; padding: 5px;"> MENU 3 / 3 F1:PARAMETERS 1 F2:CONTRAST ADJ. P↓ </div>
2 Press the [F2] key.	[F2]	<div style="border: 1px solid black; padding: 5px;"> CONTRAST ADJUSTMENT LEVEL: 4 ↓ ↑ --- ENTER </div>
3 Press the [F1](↓) key or [F2](↑) key, and press the [F4](ENTER) key.	[F1]or [F2] [F4]	

6.6 ROAD

•Road menu operation

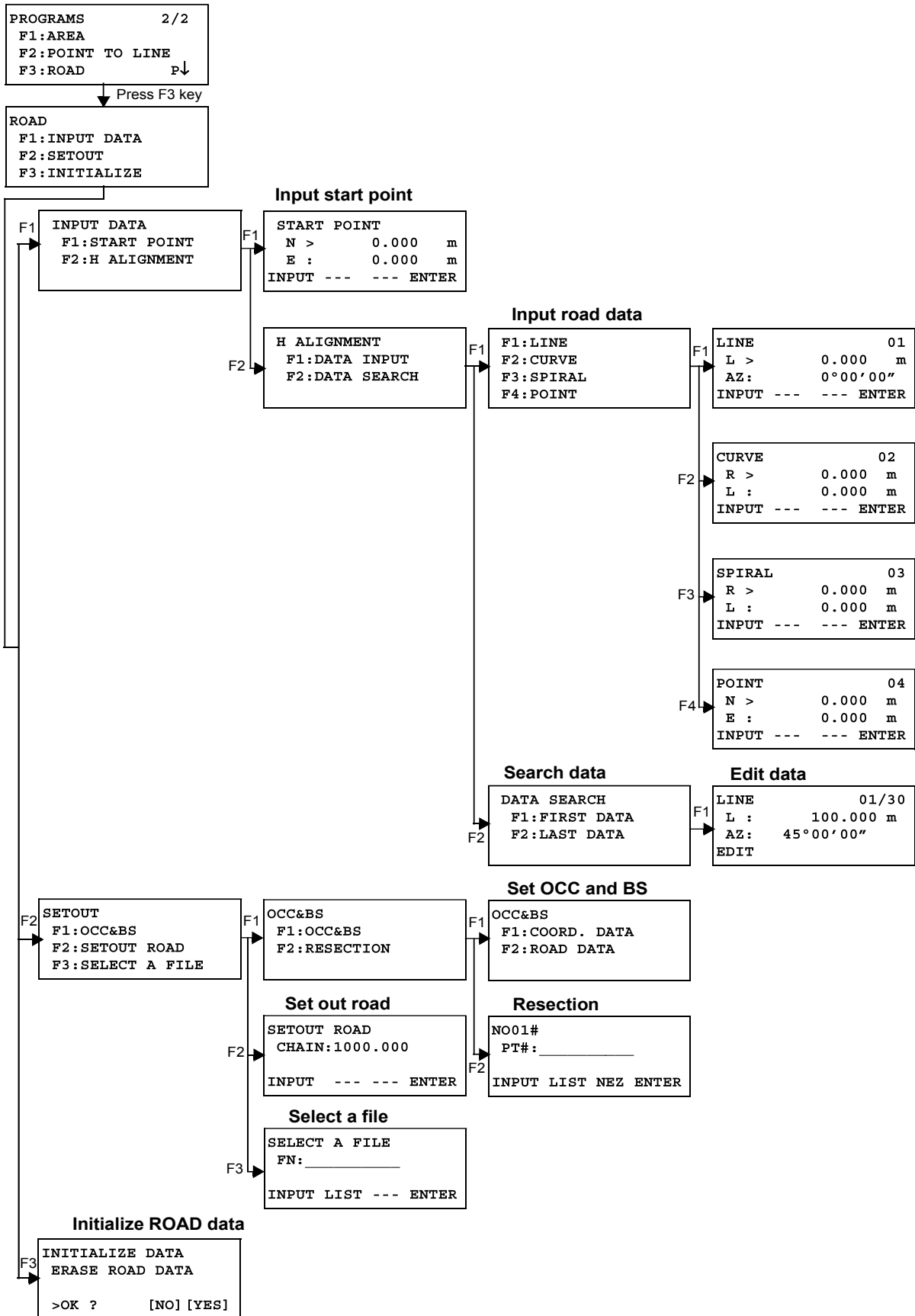

6.6.1 Input Start Point

To input the start point, carry out the following operating procedure.

Operating procedure	Operation	Display
1 After pressing the [MENU] key, press the [F4](P↓), [F1], [F4] key to get the programs menu on page 2/2.	[MENU] [F4] [F1] [F4]	<pre>PROGRAMS 2/2 F1:AREA F2:POINT TO LINE F3:ROAD P↓</pre>
2 Press the [F3], [F1], [F1] key. (Refer to "Input start point" on page 6-23.)	[F3] [F1] [F1]	<pre>START POINT N = 0.000 m E : 0.000 m --- --- [CLR] [ENT]</pre>
3 Input coord N, E. 4 Press the [ENT] key.	Input coord [ENT]	<pre>START POINT CHAIN = 0.000 m INTERVAL:100.000 m --- --- [CLR] [ENT]</pre>
5 Input value data CHAIN, INTERVAL. 6 Press the [ENT] key.	Input data [ENT]	<pre><SET!></pre> <pre>INPUT DATA F1:START POINT F2:H ALIGNMENT</pre>
<p>•For [ROAD], in addition to the "Start Point" and "Road Data" input files, other files necessary for the calculations are created. Consequently, if the free area of the memory reaches 10% or less, a "MEMORY POOR" warning message is displayed. (In this case, the instrument can still be operated.)</p> <p>•CHAIN and INTERVAL input range</p> <p>-50,000m ≤ CHAIN ≤ +500,000m 0m < INTERVAL ≤ +5,000m</p>		

6.6.2 Input Road Data

[ROAD] is made up of four types of components: LINE, CURVE, SPIRAL and POINT.
To input the required components, carry out the following operating procedure.

Operating procedure	Operation	Display
1 After pressing the [MENU] key, press the [F4](P↓), [F1], [F4] key to get the programs menu on page 2/2.	[MENU] [F4] [F1] [F4]	<div style="border: 1px solid black; padding: 5px;"> PROGRAMS 2 / 2 F1 : AREA F2 : POINT TO LINE F3 : ROAD P↓ </div>
2 Press the [F3], [F1], [F2],[F1] key. (Refer to "Input road data" on page 6-23.)	[F3] [F1] [F2] [F1]	<div style="border: 1px solid black; padding: 5px;"> F1 : LINE F2 : CURVE F3 : SPIRAL F4 : POINT </div>
•The amount of input data varies depending on the type of data, up to a maximum of 30. (In the case of POINT input only, the maximum is 9 points including end point.) •An error may occur when entering a combination of POINT and other components if the amount of data entered exceeds the maximum amount allowed for internal calculations. If this happens, please reduce the amount of input data.		

•Input LINE data

Operating procedure	Operation	Display
1 To input LINE data, press the [F1] key. *1)	[F1]	<div style="border: 1px solid black; padding: 5px;"> F1 : LINE F2 : CURVE F3 : SPIRAL F4 : POINT </div>
2 Input LENGTH. 3 Press the [ENT] key.	Input LENGTH [ENT]	<div style="border: 1px solid black; padding: 5px;"> LINE 01 L = 0.000 m AZ: 0°00'00" --- --- [CLR] [ENT] </div>
4 Input AZIMUTH. 5 Press the [ENT] key.	Input AZIMUTH [ENT]	<div style="border: 1px solid black; padding: 5px;"> LINE 01 L : 100.000 m AZ= 0°00'00" --- --- [CLR] [ENT] </div> <p style="text-align: center;">⋮</p> <div style="border: 1px solid black; padding: 10px; text-align: center; margin-top: 20px;"> <SET!> </div>
*1) The number at the top right of the screen shows the amount of data currently entered.		

•Input CURVE data

Operating procedure	Operation	Display
<p>1 To input CURVE data, press the [F2] key. *1)</p> <p>2 Input RADIUS.</p> <p>3 Press the [ENT] key.</p> <p>4 Input LENGTH.</p> <p>5 Press the [ENT] key.</p> <p>6 Select TURN(direction of turn): RIGHT or LEFT.</p> <p>7 Press the [ENT] key.</p>	<p>[F2]</p> <p>Input RADIUS [ENT]</p> <p>Input LENGTH [ENT]</p> <p>Select [F1](LEFT) or [F2](RIGHT) [ENT]</p>	<div style="border: 1px solid black; padding: 2px; margin-bottom: 2px;"> <p>F1:LINE F2:CURVE F3:SPIRAL F4:POINT</p> </div> <div style="border: 1px solid black; padding: 2px; margin-bottom: 2px;"> <p>CURVE 02 R = 0.000 m L : 0.000 m --- --- [CLR] [ENT]</p> </div> <div style="border: 1px solid black; padding: 2px; margin-bottom: 2px;"> <p>CURVE 02 R : 100.000 m L = 0.000 m --- --- [CLR] [ENT]</p> </div> <div style="border: 1px solid black; padding: 2px; margin-bottom: 2px;"> <p style="text-align: center;">⋮</p> </div> <div style="border: 1px solid black; padding: 2px; margin-bottom: 2px;"> <p>CURVE 02 TURN > RIGHT LEFT RIGHT --- ENTER</p> </div> <div style="border: 1px solid black; padding: 2px; margin-bottom: 2px;"> <p style="text-align: center;"><SET!></p> </div>
<p>*1) CURVE cannot be input as the first data.</p>		

•Input SPIRAL data

Operating procedure	Operation	Display
		<pre> F1:LINE F2:CURVE F3:SPIRAL F4:POINT </pre>
1 To input SPIRAL data, press the [F3] key. *1)	[F3]	<pre> SPIRAL 03 R = 0.000 m L : 0.000 m --- --- [CLR] [ENT] </pre>
2 Input RADIUS. 3 Press the [ENT] key.	Input RADIUS [ENT]	<pre> SPIRAL 03 R : 100.000 m L = 0.000 m --- --- [CLR] [ENT] </pre>
4 Input LENGTH. 5 Press the [ENT] key.	Input LENGTH [ENT]	⋮
6 Select TURN(direction of turn): RIGHT or LEFT. 7 Press the [ENT] key.	Select [F1](LEFT) or [F2](RIGHT) [ENT]	<pre> SPIRAL 03 TURN > RIGHT DIR : IN LEFT RIGHT --- ENTER </pre>
8 Select DIR(direction): IN(entrance) or OUT(exit). 9 Press the [ENT] key.	Select [F1](IN) or [F2](OUT) [ENT]	<pre> SPIRAL 03 TURN : LEFT DIR > IN IN OUT --- ENTER </pre>
		<SET!>
*1) SPIRAL cannot be input as the first data.		

•Input POINT data

Operating procedure	Operation	Display
1 To input POINT data, press the [F4] key.	[F4]	<div style="border: 1px solid black; padding: 2px;"> F1:LINE F2:CURVE F3:SPIRAL F4:POINT </div> <div style="border: 1px solid black; padding: 2px;"> POINT 04 N = 0.000 m E : 0.000 m --- --- [CLR] [ENT] </div>
2 Input N coord. 3 Press the [ENT] key.	Input N coord [ENT]	<div style="border: 1px solid black; padding: 2px;"> POINT 04 N : 100.000 m E = 0.000 m --- --- [CLR] [ENT] </div>
4 Input E coord. 5 Press the [ENT] key.	Input E coord [ENT]	<div style="border: 1px solid black; padding: 2px;"> R > 0.000 m A1: 0.000 A2: 0.000 INPUT --- SKIP ENTER </div>
6 Input RADIUS. *1) 7 Press the [ENT] key.	Input RADIUS [ENT]	<div style="border: 1px solid black; padding: 2px;"> R : 100.000 m A1> 0.000 A2: 0.000 INPUT --- SKIP ENTER </div>
8 Input parameter A1. *1) 9 Press the [ENT] key.	Input parameter A1 [ENT]	<div style="border: 1px solid black; padding: 2px;"> R : 100.000 m A1: 80.000 A2> 0.000 INPUT --- SKIP ENTER </div>
10 Input parameter A2. *1) 11 Press the [ENT] key.	Input parameter A2 [ENT]	<div style="border: 1px solid black; padding: 2px;"> <div style="border: 1px solid black; width: 100%; height: 30px; text-align: center; margin-top: 10px;"> <SET!> </div> </div>
<p>*1) If the data input is not required, press the [SKIP] key.</p> <p>•When inputting POINT data, if the next data is not POINT data, ROAD is calculated as a straight line irrespective of the values for RADIUS, A1 and A2.</p>		

6.6.3 Search Data

To search for input data, carry out the following operating procedure.

Operating procedure	Operation	Display
1 After pressing the [MENU] key, press the [F4](P↓), [F1], [F4] key to get the programs menu on page 2/2.	[MENU] [F4] [F1] [F4]	<pre> PROGRAMS 2/2 F1:AREA F2:POINT TO LINE F3:ROAD P↓ </pre>
2 Press the [F3], [F1], [F2], [F2] key. (Refer to "Search data" on page 6-23.)	[F3] [F1] [F2] [F2]	<pre> DATA SEARCH F1:FIRST DATA F2:LAST DATA </pre>
3 To search from the first data, select [F1] (FIRST DATA).	[F1]	<pre> LINE 01/30 L : 100.000 m AZ: 45°00'00" EDIT ↓ </pre>
4 To switch to different data, press the [↓] or [↑] key.	[↓] or [↑]	<pre> </pre> <p style="text-align: center;">⋮</p> <pre> SPIRAL 30/30 R : 200.000 m L : 100.000 m EDIT ↓ </pre>

6.6.4 Edit Data

To edit input data, carry out the following operating procedure.

Operating procedure	Operation	Display
1 In DATA SEARCH, press the [F1] key.	[F1]	<pre> LINE 01/30 L : 100.000 m AZ: 45°00'00" EDIT ↓ </pre>
2 Edit the data.	Edit data	<pre> LINE 01 L = 100.000 m AZ: 45°00'00" --- --- [CLR] [ENT] </pre>

6.6.5 Set OCC and BS

To set the Occupied Point and Backsight Point, carry out the following operating procedure.

Operating procedure	Operation	Display
<p>1 After pressing the [MENU] key, press the [F4](P↓), [F1], [F4]key to get the programs menu on page 2/2.</p>	[MENU] [F4] [F1] [F4]	<pre>PROGRAMS 2/2 F1:AREA F2:POINT TO LINE F3:ROAD P↓</pre>
<p>2 Press the [F3], [F2], [F1] key. (Refer to "Set OCC and BS" on page 6-23.)</p>	[F3] [F2] [F1]	<pre>OCC&BS F1:OCC&BS F2:RESECTION</pre>
<p>3 Press the [F1] key. *1)</p>	[F1]	<pre>OCC&BS F1:COORD. DATA F2:ROAD DATA</pre>
<p>4 To input OCC. PT, press the [F1](COORD. DATA)or [F2](ROAD DATA) key.</p> <p>COORD. DATA: Choose the data from Coord Data and set the Occupied Point.</p> <p>ROAD DATA: Create the data from Road Data and set the Occupied Point.</p> <p>(Example : ROAD DATA)</p>	[F2]	<pre>OCC.PT CHAIN= --- --- [CLR] [ENT]</pre>
<p>5 Input OCC. PT, press the [ENT] key.</p>	Input OCC. PT [ENT]	<pre>CHAIN:1000.000 >CENTER LEFT RIGHT --- ENTER</pre>
<p>6 Press the [ENT] key.</p> <p>LEFT or RIGHT: Use the offset point. CENTER: Use the center point.</p> <p>(Example : CENTER)</p>	[ENT]	<pre>CHAIN:1000.000 N : 0.000 m E : 0.000 m >OK ? [YES] [NO]</pre>
<p>7 Press the [F3](YES) key.</p>	[F3]	<pre>BACKSIGHT CHAIN= --- --- [CLR] [ENT]</pre>
<p>8 Input the backsight.</p>	Input Backsight	
<p>9 Press the [ENT] key.</p>	[ENT]	<pre>CHAIN: 0.000 >CENTER LEFT RIGHT --- ENTER</pre>

10 Collimate the backsight.

Collimate
Backsight

BACKSIGHT
H(B) = 45°00'00"
>Sight? [YES] [NO]

11 Press the [F3](YES) key.

[F3]

<SET!>

SETOUT
F1:OCC&BS
F2:SETOUT ROAD
F3:SELECT A FILE

*1) When setting the Occupied Point and Backsight Point using Resection method, select [F2]
(RESECTION).
For details of the Resection method, refer to Section 8.3.2 "Resection Method".

6.6.6 Setout Road

To setout the road, carry out the following operating procedure.

Operating procedure	Operation	Display
1 After pressing the [MENU] key, press the [F4](P↓), [F1], [F4] key to get the programs menu on page 2/2.	[MENU] [F4] [F1] [F4]	<pre> PROGRAMS 2/2 F1:AREA F2:POINT TO LINE F3:ROAD P↓ </pre>
2 Press the [F3], [F2], [F2] key. (Refer to "Set out road" on page 6-23.)	[F3] [F2] [F2]	<pre> SETOUT ROAD CHAIN= --- --- [CLR] [ENT] </pre>
3 Input data.	Input data	<pre> SETOUT ROAD CHAIN=1200 --- --- [CLR] [ENT] </pre>
4 Press the [ENT] key.	[ENT]	<pre> CHAIN:1200 > CENTER LEFT RIGHT --- ENTER </pre>
5 Select offset. (Example: RIGHT) Press the [F2] key. *1)	[F2]	<pre> CHAIN:1200 : RIGHT = m --- --- [CLR] [ENT] </pre>
6 Input the offset value.	Input offset value	
7 Press the [ENT] key. The setout point coordinates are displayed.	[ENT]	<pre> CHAIN:1200 N : 0.000 m E : 0.000 m >OK ? [YES] [NO] </pre>
8 Press the [F3](YES) key. The distance to the setout point and the backsight are displayed. HR: Calculated horizontal angle of the layout point HD: Calculated horizontal distance from the instrument to the layout point	[F3]	<pre> CALCULATED HR= 60°00'00" HD= 100.000 m ANG DIST --- --- </pre>
9 Press the [F1](ANG) key. CHAIN: Layout point HR: Measured (Actual) horizontal angle. dHR: Horizontal angle to be turned to the layout point = Actual horizontal angle - Calculated horizontal angle. Correct direction when dHR = 0°00'00"	[F1]	<pre> CHAIN:1200 HR: 60°00'00" dHR: 0°00'00" DIST --- NEZ --- </pre>
10 Press the [F1](DIST) key. HD: Measuring (Actual) horizontal distance dHD: Horizontal distance to be turned to the layout point = Actual horizontal distance - Calculated horizontal distance.	[F1]	<pre> HD* 100.000 m dHD: 0.000 m MODE ANG NEZ NEXT </pre>

11 Press the [F3](NEZ) key. The coordinate data is shown.	[F3]	<table border="1"> <tr> <td>N *</td> <td>70.000 m</td> </tr> <tr> <td>E :</td> <td>50.000 m</td> </tr> <tr> <td>MODE</td> <td>ANG --- NEXT</td> </tr> </table>	N *	70.000 m	E :	50.000 m	MODE	ANG --- NEXT
N *	70.000 m							
E :	50.000 m							
MODE	ANG --- NEXT							
12 Press the [F4](NEXT) key to set next layout point.	[F4]							
*1) If not selecting offset, press the [ENT] key.								

6.6.7 Select a File

To set the coordinates to be used for the Occupied Point and Backsight Point, carry out the following operating procedure.

Operating procedure	Operation	Display								
1 After pressing the [MENU] key, press the [F4](P↓), [F1], [F4] key to get the programs menu on page 2/2.	[MENU] [F4] [F1] [F4]	<table border="1"> <tr> <td>PROGRAMS</td> <td>2 / 2</td> </tr> <tr> <td>F1: AREA</td> <td></td> </tr> <tr> <td>F2: POINT TO LINE</td> <td></td> </tr> <tr> <td>F3: ROAD</td> <td>P↓</td> </tr> </table>	PROGRAMS	2 / 2	F1: AREA		F2: POINT TO LINE		F3: ROAD	P↓
PROGRAMS	2 / 2									
F1: AREA										
F2: POINT TO LINE										
F3: ROAD	P↓									
2 Press the [F3], [F2] key. (Refer to "Select a file" on page 6-23.)	[F3] [F2]	<table border="1"> <tr> <td>SETOUT</td> </tr> <tr> <td>F1: OCC&BS</td> </tr> <tr> <td>F2: SETOUT ROAD</td> </tr> <tr> <td>F3: SELECT A FILE</td> </tr> </table>	SETOUT	F1: OCC&BS	F2: SETOUT ROAD	F3: SELECT A FILE				
SETOUT										
F1: OCC&BS										
F2: SETOUT ROAD										
F3: SELECT A FILE										
3 Press the [F3] key.	[F3]	<table border="1"> <tr> <td>SELECT A FILE</td> </tr> <tr> <td>FN: _____</td> </tr> <tr> <td>INPUT LIST --- ENTER</td> </tr> </table>	SELECT A FILE	FN: _____	INPUT LIST --- ENTER					
SELECT A FILE										
FN: _____										
INPUT LIST --- ENTER										
4 Enter the name of the file being used (or select it from the list).	Select a file									
5 Press the [ENT] key.	[ENT]									

6.6.8 Initialize ROAD data

To initialize the data, carry out the following operating procedure.

Operating procedure	Operation	Display								
1 After pressing the [MENU] key, press the [F4](P↓), [F1], [F4] key to get the programs menu on page 2/2.	[MENU] [F4] [F1] [F4]	<table border="1"> <tr> <td>PROGRAMS</td> <td>2 / 2</td> </tr> <tr> <td>F1: AREA</td> <td></td> </tr> <tr> <td>F2: POINT TO LINE</td> <td></td> </tr> <tr> <td>F3: ROAD</td> <td>P↓</td> </tr> </table>	PROGRAMS	2 / 2	F1: AREA		F2: POINT TO LINE		F3: ROAD	P↓
PROGRAMS	2 / 2									
F1: AREA										
F2: POINT TO LINE										
F3: ROAD	P↓									
2 Press the [F3], [F3] key. (Refer to "Initialize ROAD data" on page 6-23.)	[F3] [F3]	<table border="1"> <tr> <td>INITIALIZE DATA</td> </tr> <tr> <td>ERASE ROAD DATA</td> </tr> <tr> <td>>OK ? [NO] [YES]</td> </tr> </table>	INITIALIZE DATA	ERASE ROAD DATA	>OK ? [NO] [YES]					
INITIALIZE DATA										
ERASE ROAD DATA										
>OK ? [NO] [YES]										
3 When the [F4] (YES) key is pressed, all ROAD DATA with the exception of the coordinate data file is erased.	[F4]									
Press the [F4] key.										

7 DATA COLLECTION

The FTS 300 series are able to store the measured data into the internal memory. The internal memory is shared by the measured data files and the coordinate data files. Maximum 30 files can be generated.

•**Measured data**

The collected data is memorized into a files.

•**The number of measurement points**

(In case not using the internal memory in layout mode)

MAX. 24,000 points

Because the internal memory covers both data collection mode and layout mode, the number of measurement points will be decreased when the layout mode is used.

For the internal memory, refer to Chapter 9 "MEMORY MANAGER MODE".

- | |
|--|
| <ol style="list-style-type: none">1) When turning off the power, ensure that you are in the main menu screen or main angle measurement mode.
This ensures completion of the memory access process and avoids possible damage to the stored data.2) It is recommended for safety to charge the battery (BT-G1) beforehand and prepare fully charged spare batteries. |
|--|

•Data collect menu operation

By pressing the [MENU] key, the instrument will be in MENU 1/3 mode.
Press the [F1](DATA COLLECT) key, the menu of data collect 1/2 will be shown.

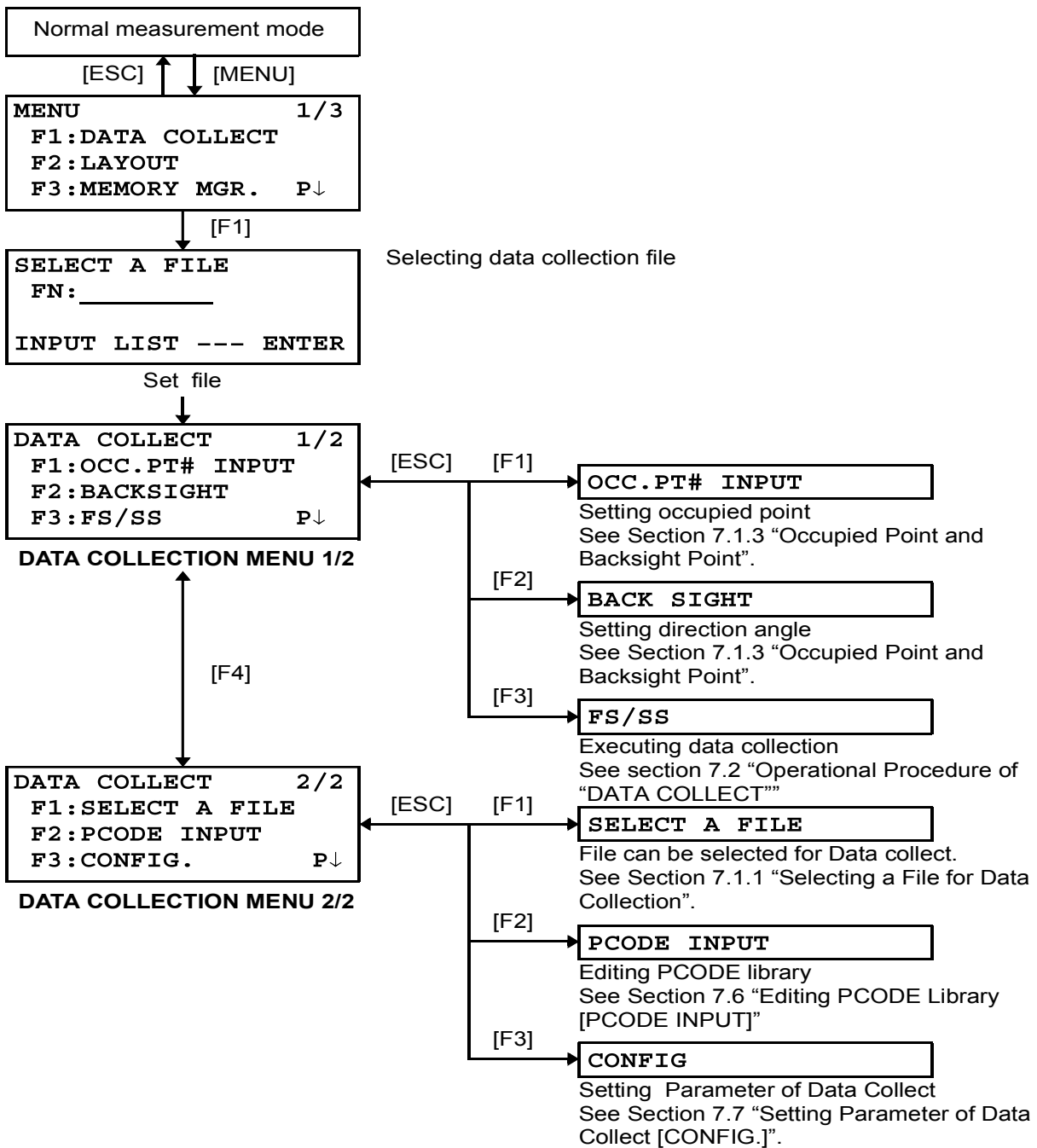

7.1 Preparation

7.1.1 Selecting a File for Data Collection

A file used by data collection mode must be selected at first.

Select a file before beginning data collection mode because selection screen of a file is displayed. And a selection from data collection menu is possible in the mode.

Operating procedure	Operation	Display
1 Press [F1](DATA COLLECT) key from menu 1/3.	[F1]	<pre> MENU 1/3 F1:DATA COLLECT F2:LAYOUT F3:MEMORY MGR. P↓ </pre>
2 Press [F2](LIST) key to display the list of file. *1)	[F2]	<pre> SELECT A FILE FN: _____ INPUT LIST --- ENTER </pre>
3 Scroll file list by pressing [▼] or [▲] key and select a file to use. *2),3)	[▼] or [▲]	<pre> AMIDATA /M0123 →*HILDATA /M0345 TOPDATA /M0789 --- SRCH --- ENTER </pre>
4 Press [F4](ENTER) key. The file will be set and data collect 1/2 menu will be shown.	[F4]	<pre> TOPDATA /M0789 →RAPDATA /M0564 SATDATA /M0456 --- SRCH --- ENTER </pre>
4 Press [F4](ENTER) key. The file will be set and data collect 1/2 menu will be shown.	[F4]	<pre> DATA COLLECT 1/2 F1:OCC.PT# INPUT F2:BACKSIGHT F3:FS/SS P↓ </pre>
<p>*1) If you want to make a new file or input file name directly, press [F1](INPUT) key and enter a file name. *2) When a file has been selected already, '*' mark is indicated on left of current file name. *3) Data in a file shown with arrow can be searched by pressing [F2](SRCH) key.</p> <p>•It is possible to select a file from DATA COLLECT 2/2 menu in the same way.</p>		<pre> DATA COLLECT 2/2 F1:SELECT A FILE F2:PCODE INPUT F3:CONFIG. P↓ </pre>

7.1.2 Selecting a Coordinate File for Data Collection

When coordinate data in a coordinate data file are used for occupied point or backsight point, select a coordinate file from the data collect menu 2/2 beforehand.

Operating procedure	Operation	Display
1 Press the [F1](SELECT A FILE) key from DATA COLLECT menu 2/2.	[F1]	<pre>DATA COLLECT 2/2 F1:SELECT A FILE F2:PCODE INPUT F3:CONFIG. P↓</pre>
2 Press the [F2](COORD.DATA) key.	[F2]	<pre>SELECT A FILE F1:MEAS.DATA F2:COORD.DATA</pre>
3 Select a coordinate file in the same manner as Section 7.1.1 "Selecting a File for Data Collection".		<pre>SELECT A FILE FN: _____ INPUT LIST --- ENTER</pre>

7.1.3 Occupied Point and Backsight Point

The occupied point and direction angle in the data collect mode are linked with the occupied point and direction angle in normal coordinate measurement.

It is possible to set or change the occupied point and direction angle from the data collect mode.

Occupied point can be set by two setting methods as follow.

- 1) Setting from the coordinate data stored in the internal memory.
- 2) Direct key input.

The following three setting methods for backsight point can be selected.

- 1) Setting from the coordinate data stored in the internal memory.
- 2) Direct key input of coordinate data.
- 3) Direct key input of setting angle.

Note: See 9.4 "Coordinate Data Direct Key Input" and 9.7.2 "Loading Data" for how to store coordinate into the internal memory.

•Example for setting the occupied point:

In case of setting occupied point from the coordinate data stored in the internal memory.

Operating procedure	Operation	Display
1 Press the [F1](OCC.PT# INPUT) key from the data collect menu 1/2. The previous data is shown.	[F1]	<pre>PT# →PT-01 ID : INS.HT: 0.000 m INPUT SRCH REC OCNEZ</pre>
2 Press the [F4] (OCNEZ) key.	[F4]	<pre>OCC.PT PT#:PT-01 INPUT LIST NEZ ENTER</pre>
3 Press the [F1](INPUT) key.	[F1]	<pre>OCC.PT PT#=PT-01 [ALP] [SPC] [CLR] [ENT]</pre>

<p>4 Enter PT#, press [F4](ENT) key. *1)</p>	<p>Enter PT# [F4]</p>	<pre>PT# →PT-11 ID : INS.HT: 0.000 m INPUT SRCH REC OCNEZ</pre>
<p>5 Enter ID, INS.HT in the same way. *2),3)</p>	<p>Enter ID, INS.HT</p>	<pre>PT# :PT-11 ID : INS.HT→ 1.335 m INPUT SRCH REC OCNEZ</pre>
<p>6 Press [F3](REC) key.</p>	<p>[F3]</p>	<pre>>REC ? [YES] [NO]</pre>
<p>7 Press [F3](YES) key. The display returns to the data collect menu 1/2.</p>	<p>[F3]</p>	<pre>DATA COLLECT 1/2 F1:OCC.PT# INPUT F2:BACKSIGHT F3:FS/SS P↓</pre>
<p>*1) Refer to Section 2.5 "How to Enter Alphanumeric characters". *2) ID can be input by inputting a register number linked with PCODE Library. To show the list of PCODE library, press the [F2](SRCH) key. *3) Press the [F3](REC) key when you do not input the INS.HT. •The data recorded in data collect is PT#, ID and INS.HT. •If point is not found in internal memory "PT# DOES NOT EXIST" is displayed.</p>		

•Example for setting the direction angle:

The following is to memorize the data of the backsight after setting the backsight point from point number.

Operating procedure	Operation	Display
1 Press the [F2](BACKSIGHT) key from the data collect menu 1/2. The previous data is shown.	[F2]	BS# → PCODE : R.HT : 0.000 m INPUT 0SET MEAS BS
2 Press the [F4] (BS) key. *1)	[F4]	BACKSIGHT PT#: INPUT LIST NE/AZ ENT
3 Press the [F1](INPUT) key.	[F1]	BACKSIGHT PT#= [ALP] [SPC] [CLR] [ENT]
4 Enter PT#, press the [F4](ENT) key. *2) Enter PCODE,R.HT in the same way. *3),4)	Enter PT# [F4]	BS# →PT-22 PCODE : R.HT : 0.000 m INPUT 0SET MEAS BS
5 Press the [F3](MEAS) key.	[F3]	BS# →PT-22 PCODE : R.HT : 0.000 m *VH SD NEZ ---
6 Collimate back sight point. Select one of the measuring mode and press the soft key. EXAMPLE : [F2](Slope Distance) key. Measuring starts. Horizontal circle is set to calculated direction angle. Measuring result is memorized and the display returns to the data collect menu 1/2.	Collimate BS [F2]	V : 90°00'00" HR: 0°00'00" SD* [n] <<< m > Measuring... ↓ DATA COLLECT 1/2 F1:OCC.PT# INPUT F2:BACKSIGHT F3:FS/SS P↓
<p>*1) Pressing each time the [F3] key, the input method changes as Coordinate value, Angle, Coordinate point name alternatively.</p> <p>*2) Refer to Chapter 2.5 "How to Enter Alphanumeric characters".</p> <p>*3) PCODE can be input by inputting a register number linked with PCODE Library. To show the list of PCODE library, press the [F2](SRCH) key.</p> <p>*4) Data collect sequence can be set to [MEAS→EDIT]. Refer to Section 7.7 "Setting Parameter of Data Collect [CONFIG.]".</p> <p>•If point is not found in internal memory " PT# DOES NOT EXIST" is displayed.</p>		

7.2 Operational Procedure of "DATA COLLECT"

Operating procedure	Operation	Display
		<pre>DATA COLLECT 1/2 F1:OCC.PT# INPUT F2:BACKSIGHT F3:FS/SS P↓</pre>
<p>1 Press the [F3](FS/SS) key from the data collect menu 1/2. The previous data is shown.</p>	[F3]	<pre>PT# → PCODE : R.HT : 0.000 m INPUT SRCH MEAS ALL</pre>
<p>2 Press the [F1](INPUT) key and enter PT#. Press the [F4](ENT) key. *1)</p>	[F1] Enter PT# [F4]	<pre>PT# =PT-01 PCODE : R.HT : 0.000 m [ALP] [SPC] [CLR] [ENT]</pre>
		<pre>PT# :PT-01 PCODE → R.HT : 0.000 m INPUT SRCH MEAS ALL</pre>
<p>3 Enter PCODE, R.HT in the same way. *2),3)</p>	[F1] Enter PCODE	<pre>PT# →PT-01 PCODE :geo-FENNEL R.HT : 1.200 m INPUT SRCH MEAS ALL</pre>
<p>4 Press the [F3](MEAS) key.</p>	[F4] [F1] EnterR.HT	<pre>VH *SD NEZ OFFSET</pre>
<p>5 Collimate the target point.</p>	[F4] [F3]	
	Collimate	
<p>6 Press one of the [F1] to [F3] key. *4) Example: [F2](SD) key. Measuring starts.</p> <p>The measuring data is memorized and the display changes to the next point. *5) PT# is automatically incremented.</p>	[F2]	<pre>V : 90°10'20" HR: 120°30'40" SD* [n] < m > Measuring... < complete ></pre>
		↓
		<pre>PT# →PT-02 PCODE :geo-FENNEL R.HT : 1.200 m INPUT SRCH MEAS ALL</pre>
<p>7 Enter the next point data and collimate the next point.</p>	Collimate	
<p>8 Press [F4](ALL) key. Measuring starts in the same measuring mode of the previous point. Data is recorded.</p>	[F4]	<pre>V : 90°10'20" HR: 120°30'40" SD* [n] < m > Measuring... < complete ></pre>
		↓
<p>Continue the measuring in the same way. To finish the mode , press [ESC] key.</p>		<pre>PT# →PT-03 PCODE :geo-FENNEL R.HT : 1.200 m INPUT SRCH MEAS ALL</pre>

- *1) Refer to Section 2.5 "How to Enter Alphanumeric characters".
- *2) PCODE can be input by inputting a register number linked with PCODE Library.
To show the list of PCODE library, press the [F2](SRCH) key.
- *3) Data collect sequence can be set to [MEAS→EDIT]. See to Section 7.7 "Setting Parameter of Data Collect [CONFIG.]".
- *4) The mark "*" indicates the previous measuring mode.
- *5) You can confirm the measured data as follows. Refer to Section 7.7 "Setting Parameter of Data Collect [CONFIG.]".

```

V : 90°10'20"
HR: 120°30'40"
SD: 98.765 m
> OK ? [YES] [NO]
```

•Searching the recorded data

While executing the DATA COLLECT mode, you can search the recorded data.

Operating procedure	Operation	Display
<p>1 While executing the DATA COLLECT mode, press [F2](SRCH) key. *1)</p> <p>The using file name will appear on the top of the right side of the display.</p>	[F2]	<pre>PT# →PT-02 PCODE : R.HT : 1.200 m INPUT SRCH MEAS ALL</pre>
<p>2 Select one of three search methods by pressing [F1] to [F3] key. *2)</p>	[F1] to [F3]	<pre>SEARCH [TOPCON] F1:FIRST DATA F2:LAST DATA F3:PT# DATA</pre>
<p>*1) It is possible to see the PCODE list when the arrow is located beside PCODE or ID. *2) The operation is same as the "SEARCH" in the MEMORY MANAGER mode. For more information, refer to Section 9.2 "Searching Data".</p>		

•Entering PCODE / ID using PCODE Library

While executing the DATA COLLECT mode, you can enter PCODE /ID from PCODE Library.

Operating procedure	Operation	Display
<ol style="list-style-type: none"> 1 Move the arrow to the PCODE or ID in the DATA COLLECT mode, press the [F1](INPUT) key. 2 Enter a register number linked with PCODE library and press the [F4](ENT) key. (Example) Register number, 32 = geo-FENNEL 	[F1]	<pre>PT# :PT-02 PCODE → R.HT : 1.200 m INPUT SRCH MEAS ALL</pre>
	Enter No [F4]	<pre>PT# :PT-02 PCODE =32 R.HT : 1.200 m [ALP] [SPC] [CLR] [ENT]</pre>
		<pre>PT# :PT-02 PCODE :geo-FENNEL R.HT → 1.200 m INPUT SRCH MEAS ALL</pre>

•Entering PCODE / ID from the list of PCODE

You can also enter PCODE / ID from the list of PCODE.

Operating procedure	Operation	Display
<ol style="list-style-type: none"> 1 Move the arrow to the PCODE or ID in the DATA COLLECT mode, press the [F2](SRCH) key. 2 By pressing the following keys, the register number will increase or decrease. [▲]or[▼]:Increasing or Decreasing one by one [▶]or[◀]:By ten Increasing or Decreasing. *1) 3 Press the [F4](ENTER) key. 	[F2]	<pre>PT# :PT-02 PCODE → R.HT : 1.200 m INPUT SRCH MEAS ALL</pre>
	[▲]or[▼] [▶]or[◀]	<pre>→001:PCODE01 002:PCODE02 EDIT --- CLR ENTER</pre>
	[F4]	<pre> 031:PCODE31 →032:geo-FENNEL 033:HILTOP EDIT --- CLR ENTER</pre>
<p>*1) To edit the PCODE library, press the [F1](EDIT) key. To delete the PCODE registered with shown an arrow, press the [F3](CLR) key. PCODE can be edited in DATA COLLECT menu 2/2 or MEMORY MANAGER menu 2/3.</p>		

7.3 Data Collect Offset Measurement mode

This mode is useful when it is difficult to set up the prism directly, for example at the center of a tree. Data Collect . Offset Measurement has four measuring methods.

- Angle offset measurement
- Distance offset measurement
- Plane offset measurement
- Column offset measurement

7.3.1 Angle Offset Measurement

Place the prism at the same horizontal distance from the instrument as that of point A0 to measure.

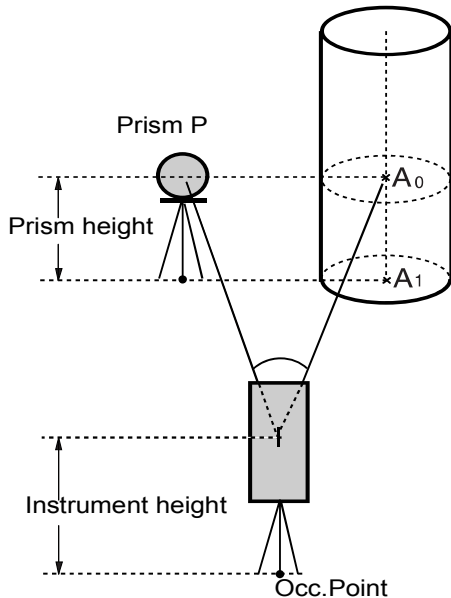





When measuring coordinates of ground point A1 : Set the instrument height / prism height.

When measuring coordinates of point A0 : Set the instrument height only. (Set the prism height to 0).

When sighting to A₀, you can select one of two ways. One is to fix vertical angle to the prism position even up down the telescope position, and the other is to gear vertical angle to the up down of telescope movement. In case following the vertical angle to the movement of telescope, SD (Slope Distance) and VD (Vertical Distance) will be changed according to the movement of telescope. To set this option, refer to Chapter 16 "SELECTING MODE".

Operating procedure	Operation	Display
1 Press the [F3](MEAS) key.	[F3]	<pre>PT# →PT-11 PCODE : geo-FENNEL R.HT : 1.200 m INPUT SRCH MEAS ALL VH *SD NEZ P1↓ OFFSET PTL P2↓</pre>
2 Press the [F4](P1↓) key, [F1](OFFSET) key.	[F4] [F1]	<pre>OFFSET 1/2 F1:ANG. OFFSET F2:DIST. OFFSET F3:PLANE OFFSET P↓</pre>
3 Press the [F1] key.	[F1]	<pre>OFFSET-MEASUREMENT HR: 120°30'40" HD: m >Sight ? [YES] [NO]</pre>
4 Collimate the prism.	Collimate P	
5 Press the [F3](YES) key. Continuous measuring starts.	[F3]	<pre>OFFSET-MEASUREMENT HR: 120°30'40" HD* [n] < m >measuring ...</pre>

<p>6 Collimate point A0 using the horizontal motion clamp and horizontal tangent screw.</p> <p>7 Show the horizontal distance of point A0.</p> <p>8 Show the relative elevation of point A0.</p> <p>•Each time pressing [] key, horizontal distance , relative elevation and slope distance are shown in sequence.</p> <p>9 Show N coordinate of point A0 or A1.</p> <p>•Each time pressing [] key, N,E and Z coordinate are shown in sequence.</p> <p>10 Press the [F3](YES) key.</p> <p>The data is recorded and the next measuring point is displayed.</p>	<p>Collimate A0</p> <p>[]</p> <p>[]</p> <p>[]</p> <p>[F3]</p>	<pre> OFFSET-MEASUREMENT HR: 120°30'40" SD* 12.345 m >OK? [YES] [NO] </pre> <pre> OFFSET-MEASUREMENT HR: 123°30'40" SD: 12.345 m >OK? [YES] [NO] </pre> <pre> OFFSET-MEASUREMENT HR: 123°30'40" HD: 6.543 m >OK? [YES] [NO] </pre> <pre> OFFSET-MEASUREMENT HR: 123°30'40" VD: 0.843 m >OK? [YES] [NO] </pre> <pre> OFFSET-MEASUREMENT HR: 123°30'40" N : -12.345 m >OK? [YES] [NO] </pre> <pre> PT# → PT-12 PCODE :geo-FENNEL R.HT : 1.200 m INPUT SRCH MEAS ALL </pre>
--	--	---

7.3.2 Distance Offset Measurement

The measurement of a place apart from a prism is possible by inputting offset horizontal distance of front and back / right and left.

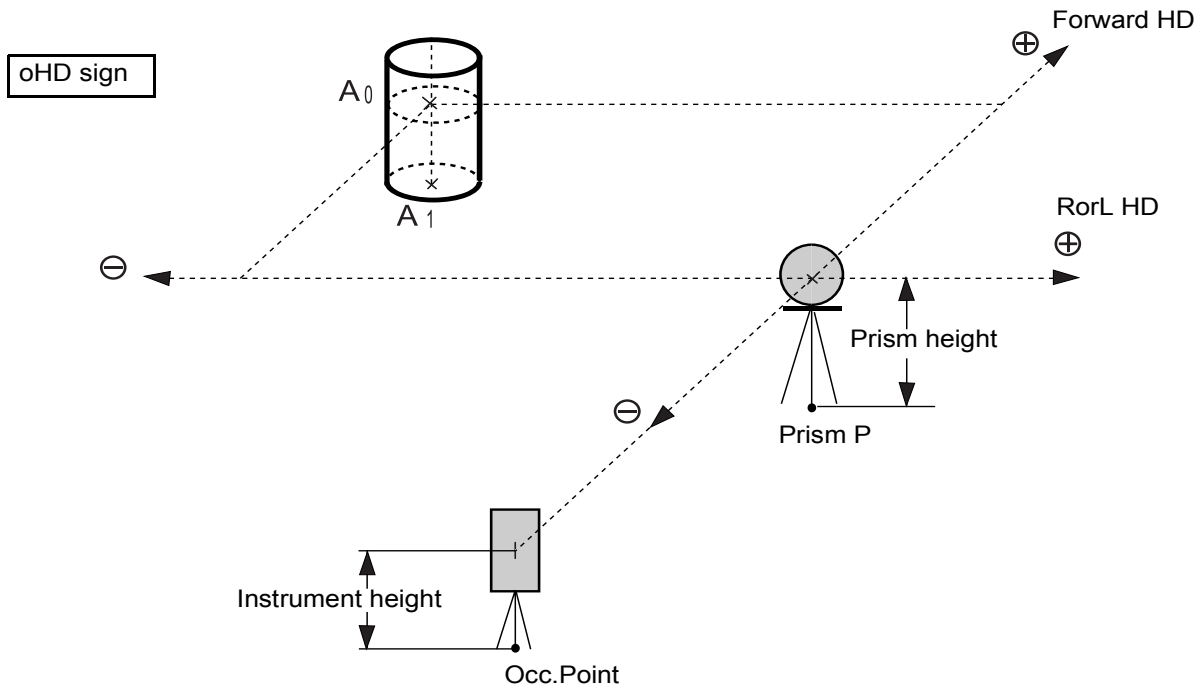

When measuring coordinates of ground point A₁: Set the instrument height / prism height.

When measuring coordinates of point A₀: Set the instrument height only.
(Set the prism height to 0).

Operating procedure	Operation	Display
1 Press the [F3](MEAS) key.	[F3]	<pre>PT# →PT-11 PCODE :geo-FENNEL R.HT : 1.200 m INPUT SRCH MEAS ALL VH *SD NEZ P1↓ OFFSET PTL P2↓</pre>
2 Press the [F4](P1↓) key, [F1](OFFSET) key.	[F4] [F1]	<pre>OFFSET 1/2 F1:ANG. OFFSET F2:DIST. OFFSET F3:PLANE OFFSET P↓</pre>
3 Press the [F2] key.	[F2]	<pre>DISTANCE OFFSET INPUT RorL HD oHD: 0.000 m --- --- [CLR] [ENT]</pre>
4 Enter Right and Left direction offset value.*1)	Enter HD [F4]	<pre>DISTANCE OFFSET INPUT FORWARD HD oHD: 0.000 m --- --- [CLR] [ENT]</pre>
5 Enter Forward direction offset value. *1)	Enter HD [F4]	<pre>PT# :PT-11 PCODE :geo-FENNEL R.HT : 1.200 m --- *SD NEZ ---</pre>

<p>6 Collimate the prism.</p> <p>7 Press the [F2] or [F3] key. Example:[F3](NEZ) key Measuring starts.</p> <p>The data is recorded and the next measuring point is displayed.</p>	<p>Collimate P</p> <p>[F3]</p>	<div style="border: 1px solid black; padding: 5px; margin-bottom: 5px;"> <p>N* [n] <<< m E : m Z : m</p> <p>>measuring ...</p> <hr/> <p>>Calculating...</p> </div> <p style="text-align: center;">↓</p> <div style="border: 1px solid black; padding: 5px;"> <p>PT# → PT-12 PCODE : geo-FENNEL R.HT : 1.200 m INPUT SRCH MEAS ALL</p> </div>
<p>*1) To skip entering, press the [F3](SKP) key.</p>		



7.3.3 Plane Offset Measurement

Measuring will be taken for the place where direct measuring can not be done, for example distance or coordinate measuring for a edge of a plane.

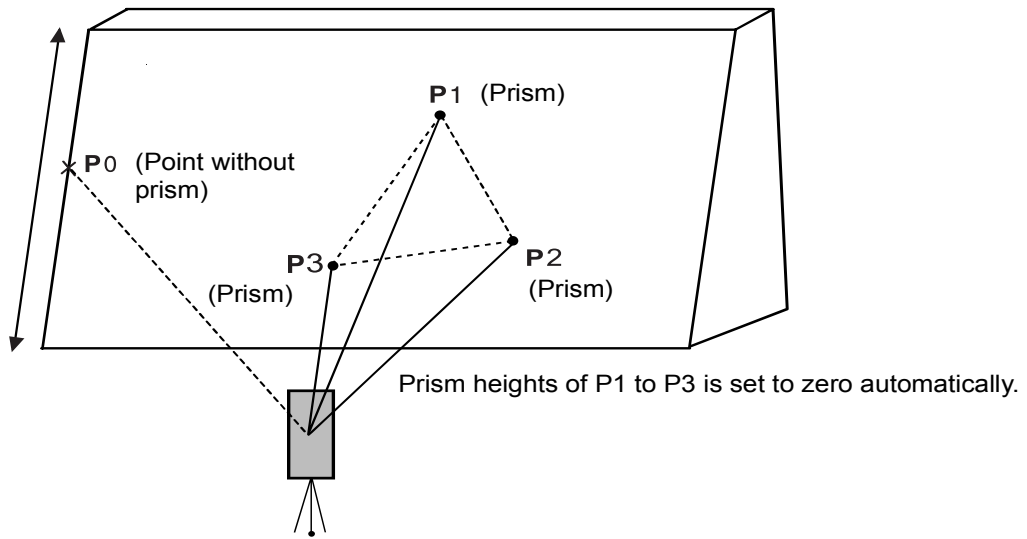
Three random points (P1, P2, P3) on a plane will be measured at first in the plane offset measurement to determine the measured plane. Collimate the measuring point (P0) then the instrument calculates and displays coordinate and distance value of cross point between collimation axis and of the plane. .



Operating procedure	Operation	Display
<p>1 Press the [F3](MEAS) key.</p>	[F3]	<pre>PT# →PT-11 PCODE :geo-FENNEL R.HT : 1.200 m INPUT SRCH MEAS ALL VH *SD NEZ P1↓ OFFSET PTL P2↓</pre>
<p>2 Press the [F4](P1↓) key, [F1](OFFSET) key.</p>	[F4] [F1]	<pre>OFFSET 1/2 F1:ANG.OFFSET F2:DIST.OFFSET F3:PLANE OFFSET P↓</pre>
<p>3 Press the [F3](PLANE OFFSET) key.</p>	[F3]	<pre>PLANE N001#: SD: m MEAS --- --- ---</pre>
<p>4 Collimate prism P1, and press the [F1](MEAS) key. Measuring will start. After measuring, the display will show the second point measurement.</p>	Collimate P1 [F1]	<pre>PLANE N001#: SD* [n] << m >Measuring...</pre> <p style="text-align: center;">↓</p>
<p>5 Measure the second and third points in the same way.</p>	Collimate P2 [F1]	<pre>PLANE N002#: SD: m MEAS --- --- ---</pre> <p style="text-align: center;">↓</p>

<p>The display changes to PT# input in the plane offset measurement. *1) Input point number if necessary.</p> <p>6 Press the [F4](MEAS) key. The instrument calculates and displays coordinate and distance value of cross point between collimation axis and of the plane. *2)</p> <p>7 Collimate the edge (P0) of the plane. *3), 4)</p> <p>8 To show the slope distance (SD), press the [] key. •Each time pressing the [] key, horizontal distance, relative elevation and slope distance are shown in sequence. •To show coordinate value of point P0, press the [] key.</p> <p>9 Press the [F3](YES) key. The measured data will be recorded and the next offset point number will be displayed.</p> <p>10 To escape the measuring, press the [ESC] key. The display returns to the next point number in data collect mode.</p>	<p>Collimate P3 [F1]</p> <p>[F4]</p> <p>Collimate P0</p> <p>[F3]</p> <p>[ESC]</p>	<pre> PLANE N003#: SD: m MEAS --- --- --- ↓ PLANE PT# →PT-11 PCODE :geo-FENNEL INPUT SRCH --- MEAS HR: 80°30'40" HD: 54.321 m VD: 10.000 m >OK? [YES] [NO] HR: 75°30'40" HD: 54.600 m VD: -0.487 m >OK? [YES] [NO] V : 90°30'40" HR: 75°30'40" SD: 54.602 m >OK? [YES] [NO] PLANE PT# →PT-12 PCODE :geo-FENNEL INPUT SRCH --- MEAS PT# →PT-12 PCODE :geo-FENNEL R.HT : 1.200 m INPUT SRCH MEAS ALL </pre>
<p>*1) In case the calculation of plane was not successful by the measured three points, error displays. Start measuring over again from the first point. *2) Data display is the mode beforehand of offset measurement mode. *3) Error will be displayed when collimated to the direction which does not cross with the determined plane. *4) The reflector height of the target point P0 is set to zero automatically</p>		



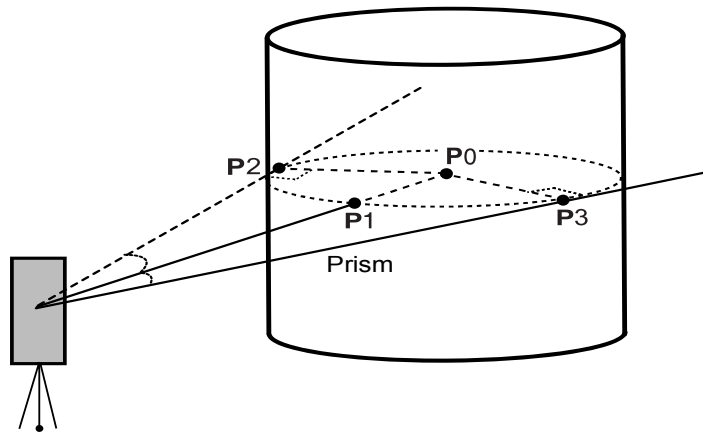

7.3.4 Column Offset Measurement

If it is possible to measure circumscription point (P1) of column directly, the distance to the center of the column (P0), coordinate and direction angle can be calculated by measured circumscription points (P2) and (P3).

The direction angle of the center of the column is 1/2 of total direction angle of circumscription points (P2) and (P3).



Operating procedure	Operation	Display
1 Press the [F3](MEAS) key.	[F3]	<pre>PT# →PT-11 PCODE :geo-FENNEL R.HT : 1.200 m INPUT SRCH MEAS ALL VH *SD NEZ P1↓ OFFSET PTL P2↓</pre>
2 Press the [F4](P1↓) key, [F1](OFSET) key.	[F4] [F1]	<pre>OFFSET 1/2 F1:ANG.OFFSET F2:DIST.OFFSET F3:PLANE OFFSET P↓</pre>
3 Press the [F4](P1↓) key.	[F4]	<pre>OFFSET 2/2 F1:COLUMN OFFSET P↓</pre>
4 Press the [F1](COLUMN OFFSET) key.	[F1]	<pre>COLUMN OFFSET Center HD: m MEAS --- --- ---</pre>
5 Collimate the center of the column (P1) and press the [F1](MEAS) key. Measuring will start.	Collimate P1 [F1]	<pre>COLUMN OFFSET Center HD* [n] << m >Measuring...</pre>
After the measurement, angle measuring display of the left side (P2) will be shown.		↓
		<pre>COLUMN OFFSET Left HR: 120°30'40" --- --- --- SET</pre>

<p>6 Collimate the left side of the column (P2) and press the [F4](SET) key. After the measurement, angle measuring display of the right side (P3) will be shown.</p>	Collimate P2 [F4]	<pre> COLUMN OFFSET Right HR: 180°30'40" --- --- --- SET </pre>
<p>7 Collimate the right side of the column (P3) and press the [F4](SET) key. The distance between the instrument and center of the column (P0) will be calculated.</p>	Collimate P3 [F4]	<pre> COLUMN OFFSET HR: 150°30'40" HD: 43.321 m >OK? [YES] [NO] </pre>
<p>To show the relative elevation (VD), press the [] key.</p> <p>Each time pressing the [] key, horizontal distance, relative elevation and slope distance are shown in sequence.</p>	[]	<pre> COLUMN OFFSET HR: 150°30'40" VD: 2.321 m >OK? [YES] [NO] </pre>
<p>To show coordinate of point P0, press the [] key.</p>		
<p>8 Press the [F3](YES) key. The display returns to the next point number in data collect mode.</p>	[F3]	<pre> PT# →PT-12 PCODE :geo-FENNEL R.HT : 1.200 m INPUT SRCH MEAS ALL </pre>

7.4 NEZ Auto Calculation

As measured data is collected, coordinates are calculated and stored for traverse or topo collection. Automatic making out function of coordinate data sets up in CONFIG of data collect. Refer to Section 7.7 "Setting Parameter of Data Collect [CONFIG.]".

As a default, coordinate data calculated will be saved in a file of the same name as the measurement data file.

When the coordinate data file of the same name as the measurement data file does not exist, it will be generated automatically.

It is possible to change a file for saving coordinate data in the DATA COLLECT Menu 2/2 (F1:SELECT A FILE).

To calculate a coordinate data, it is necessary to add a point number in Data Collect execution.

When a coordinate data of the same point number exist already, it can be replaced with the new data by confirming display.

- **Coordinates will be calculated using the grid factor.**
To set the grid factor, see Section 6.2 "Setting the GRID FACTOR".

7.5 Point to Line Measurement

In this mode, a offsetting point from a certain determined line can be measured.

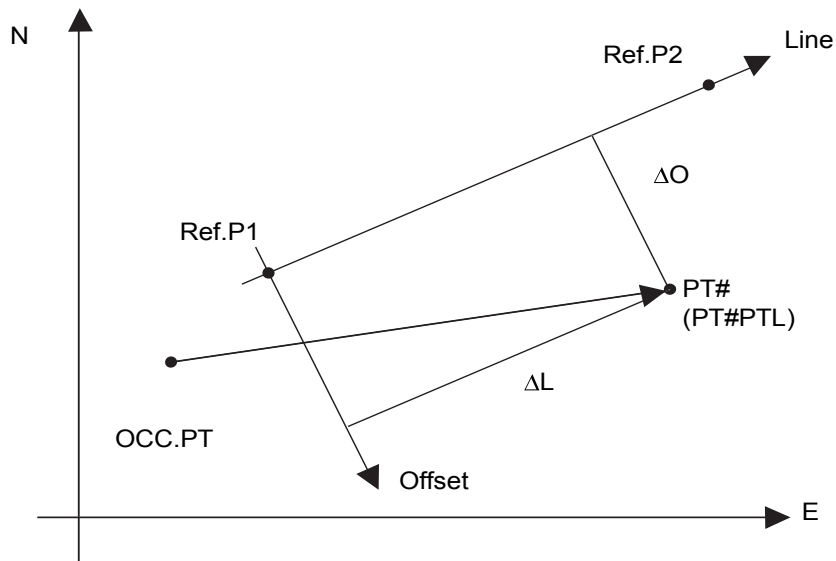

7.5.1 To change to the point to line measurement

Operating procedure	Operation	Display
<p>1 Press the [F3](MEAS) key and press the [F4]key to get to the next soft key page.</p> <p>2 Press the [F2](PTL) key.</p> <p>3 Press the [F1](ON) key and press the [F4](ENTER) key. The input screen of a reference point 1 will appear.</p> <p>4 Enter the point 1 data and press the [F4](Enter). The input screen of a reference point 2 will appear.</p> <p>5 Enter the point 2 data and press the [F4](Enter). The screen will return to data collect measurement. If the PTL measurement mode is available, 'PTL' will appear next to PT#.</p>	[F3]	<pre>PT# →PT-01 PCODE :geo-FENNEL R.HT : 1.500 m INPUT SRCH MEAS ALL</pre>
	[F4]	<pre>PT# →PT-01 PCODE :geo-FENNEL R.HT : 1.500 m VH *SD NEZ P1↓ OFFSET PTL P2↓</pre>
	[F2]	<pre>POINT TO LINE MODE [F1:ON] F2:OFF ENTER</pre>
	[F4]	<pre>REF. POINT 1 PT#: _____ INPUT LIST --- ENTER</pre>
	Input data [F4]	<pre>REF. POINT 2 PT#: _____ INPUT LIST --- ENTER</pre>
Input data [F4]	<pre>PT#PTL→PT-01 PCODE :geo-FENNEL R.HT : 1.500 m INPUT SRCH MEAS ALL</pre>	

7.5.2 Executing a point to line measurement

Operating procedure	Operation	Display
<p>Conduct data measurement according to the same procedure as with ordinary FS/SS (ALL can also be selected). However, when you conduct observation in the angle mode, PTL data will not be displayed (only the raw data will be recorded, upon which the operation will end).</p> <p>1 Press the [F3](MEAS) key.</p> <p>2 Press the [F2](SD) key. If the PTL mode is on, then, after the coordinate data is calculated, the PTL data will be displayed regardless of the coordinate check setting, etc.</p> <p>3 PTL measurement data will display. Confirm the data and press [F3](YES) key. The recorded data are measured data and coordinate data generated at the same time as a PTL data.</p>	<p>[F3]</p> <p>[F2]</p> <p>[F3]</p>	<pre>PT#PTL→PT-01 PCODE :geo-FENNEL R.HT : 1.500 m INPUT SRCH MEAS ALL</pre> <pre>PT#PTL→PT-01 PCODE :geo-FENNEL R.HT : 1.500 m VH *SD NEZ</pre> <pre>V : 90°10'20" HR: 120°30'40" SD* < m > Measuring...</pre> <pre>L: 44.789 m O: 33.456 m E: 2.321 m >REC? [YES] [NO]</pre> <pre>PT#PTL→PT-02 PCODE :geo-FENNEL R.HT : 1.500 m INPUT SRCH MEAS ALL</pre>
<p>•In the PTL measurement mode, NEZ Auto Calculation will be turned on compulsorily and the coordinate data will be stored into a coordinate file.</p>		

7.6 Editing PCODE Library [PCODE INPUT]

PCODE data can be entered into PCODE Library in this mode.

A PCODE is liked with a number of 1 to 50.

PCODE can be also edited in MEMORY MANAGER menu 2/3 in the same way.

Operating procedure	Operation	Display
<p>1 Press the [F2](PCODE INPUT) key from Data Collect menu 2/2.</p> <p>2 By pressing the following keys, the list will increase or decrease. [▲] or [▼] : Increasing or Decreasing one by one [▶] or [◀] : By ten Increasing or Decreasing.</p> <p>3 Press the [F1](EDIT) key.</p> <p>4 Enter PCODE and press the [F4](ENT) key. *1)</p>	[F2]	<pre>DATA COLLECT 2/2 F1:SELECT A FILE F2:PCODE INPUT F3:CONFIG. P↓</pre>
	[▲]or[▼] [▶]or[◀]	<pre>→ 001 :geo-FENNEL 002 :TOKYO EDIT --- CLR ---</pre>
	[F1]	<pre>011 :URAH → 012 :AMIDAT 013 :HILLTO EDIT --- CLR ---</pre>
	Enter PCODE [F4]	<pre>011 :URAH → 012 :<u>A</u>MIDAT 013 :HILLTO [ALP] [SPC] [CLR] [ENT]</pre> <pre>011 :URAH → 012 :<u>A</u>MISUN 013 :HILLTO EDIT --- CLR ---</pre>
*1) Refer to Section 2.5 "How to Enter Alphanumeric characters".		

7.7 Setting Parameter of Data Collect [CONFIG.]

In this mode, the following settings of data collect mode are possible.

•Setting Items

Menu	Selecting Item	Contents
F1:DIST MODE	FINE / CRS(1) / CRS(10)	Select Fine /Coarse(1) /Coarse(10) mode in distance measurement mode. The unit to be displayed is as follows. Fine mode: 1mm (0.2mm) Coarse (1) mode: 1mm Coarse (10) mode: 10mm
F2:HD/SD	HD/SD	Select the distance measurement mode Horizontal distance or Slope distance.
F3:MEAS. SEQ.	N-TIMES / SINGLE / REPEAT	Select to set measurement mode for distance measurement.
F1:DATA CONFIRM	YES/NO	It is possible to confirm the result of measuring data before the data is recorded.
F2:COLLECT SEQ.	[EDIT→MEAS] / [MEAS→EDIT]	Select the procedure of data collection. [EDIT→MEAS] :Measurement is carried out after entering other data. [MEAS→EDIT] :Measurement is carried out before entering other data.
F3:NEZ AUTO. CALC	ON/OFF	It is possible to calculate coordinate value of data collected and store it into coordinate data file in every data collection.

•How to Set Items

Example Setting: DATA CONFIRM : YES

Operating procedure	Operation	Display								
1 Press the [F3] (CONFIG.) key from the data collect menu 2/2. The CONFIG menu 1/2 is shown.	[F3]	<table border="1"> <tr> <td>DATA COLLECT</td> <td>2 / 2</td> </tr> <tr> <td>F1:SELECT A FILE</td> <td></td> </tr> <tr> <td>F2:PCODE INPUT</td> <td></td> </tr> <tr> <td>F3:CONFIG.</td> <td>P↓</td> </tr> </table>	DATA COLLECT	2 / 2	F1:SELECT A FILE		F2:PCODE INPUT		F3:CONFIG.	P↓
DATA COLLECT	2 / 2									
F1:SELECT A FILE										
F2:PCODE INPUT										
F3:CONFIG.	P↓									
2 Press the [F4](P↓) key to display the CONFIG menu 2/2.	[F4]	<table border="1"> <tr> <td>CONFIG.</td> <td>1 / 2</td> </tr> <tr> <td>F1:DIST MODE</td> <td></td> </tr> <tr> <td>F2:HD/SD</td> <td></td> </tr> <tr> <td>F3:MEAS. SEQ.</td> <td>P↓</td> </tr> </table>	CONFIG.	1 / 2	F1:DIST MODE		F2:HD/SD		F3:MEAS. SEQ.	P↓
CONFIG.	1 / 2									
F1:DIST MODE										
F2:HD/SD										
F3:MEAS. SEQ.	P↓									
3 Press the [F1] (DATA CONFIRM) key. [] indicates the current setting.	[F1]	<table border="1"> <tr> <td>DATA CONFIRM</td> <td></td> </tr> <tr> <td>F1:YES</td> <td></td> </tr> <tr> <td>[F2:NO]</td> <td></td> </tr> <tr> <td></td> <td>ENTER</td> </tr> </table>	DATA CONFIRM		F1:YES		[F2:NO]			ENTER
DATA CONFIRM										
F1:YES										
[F2:NO]										
	ENTER									
4 Press the [F1] (YES) key.	[F1]	<table border="1"> <tr> <td>DATA CONFIRM</td> <td></td> </tr> <tr> <td>[F1:YES]</td> <td></td> </tr> <tr> <td>F2:NO</td> <td></td> </tr> <tr> <td></td> <td>ENTER</td> </tr> </table>	DATA CONFIRM		[F1:YES]		F2:NO			ENTER
DATA CONFIRM										
[F1:YES]										
F2:NO										
	ENTER									
5 Press the [F4] (ENTER) key.	[F4]									

8 LAYOUT

LAYOUT mode has two functions which are setting of layout points and setting new points using coordinate data in the internal memory.

Also, if the coordinate data is not stored in the internal memory, this can be input from key board.

The coordinate data is loaded from PC to the internal memory via RS-232C.

•The coordinate data

The coordinate data is memorized into a file.

For the internal memory, refer to Chapter 9 "MEMORY MANAGER MODE".

The FTS 300 series are able to store the coordinate data into the internal memory.

The internal memory is shared by the measured data and the coordinate data for layout.

Maximum 30 files can be generated.

•The number of coordinate data

(In case not using the internal memory in the data collect mode)

MAX. 24,000 points

Because the internal memory covers both data collection mode and layout mode, the number of coordinate data will be decreased when the data collection mode is used.

- | |
|---|
| <ol style="list-style-type: none"> 1) When turning off the power, ensure that you are in the main menu screen or main angle measurement mode.
This ensures completion of the memory access process and avoids possible damage to the stored data. 2) It is recommended for safety to charge the battery (BT-G1) beforehand and prepare fully charged spare batteries. 3) When recording new point data, remember to consider the amount of internal memory available. |
|---|

• Layout menu operation

By pressing the [MENU] key, the instrument will be in MENU 1/3 mode.
 Press the [F2](LAYOUT) key, the menu of layout 1/2 will be shown.

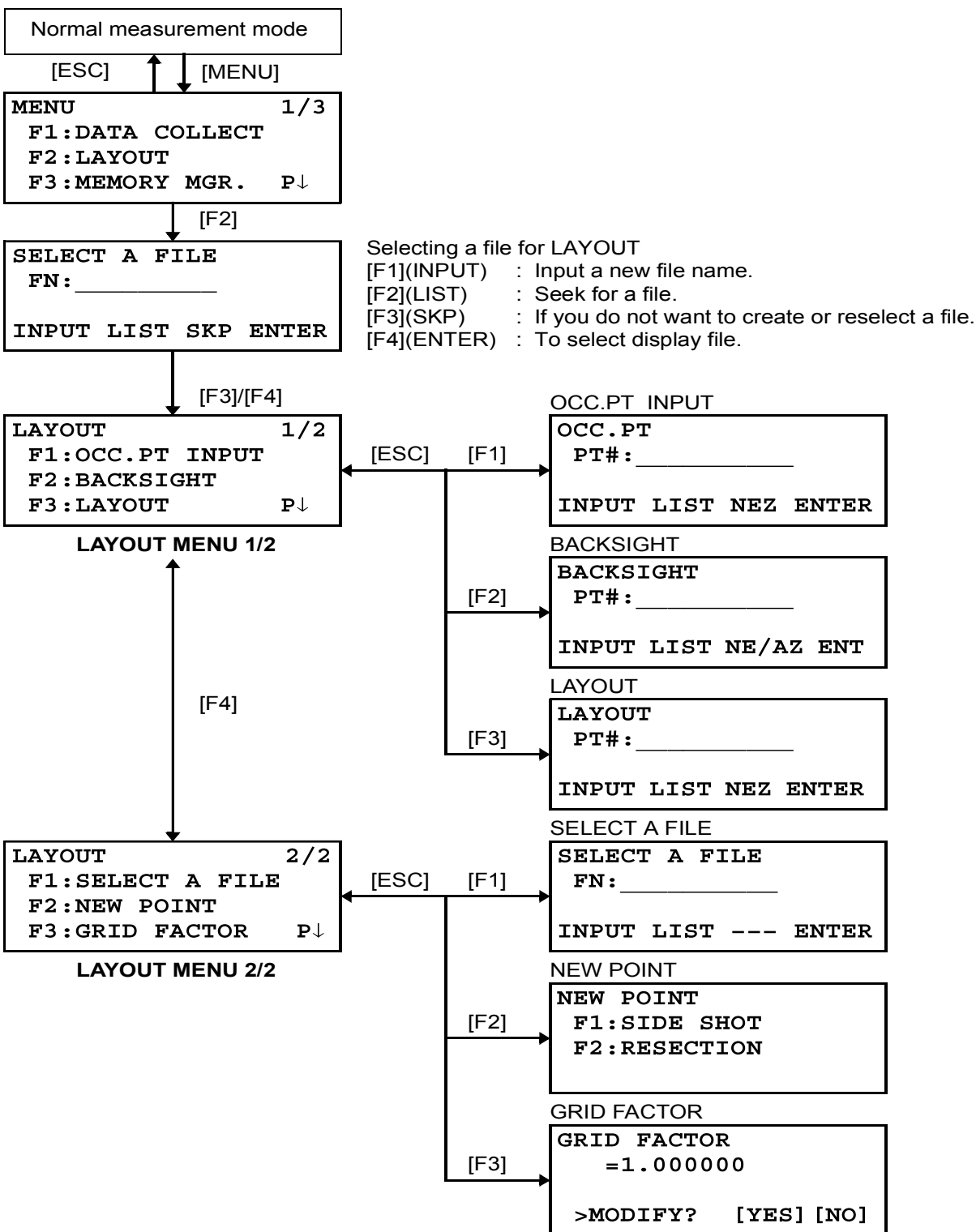

8.1 Preparation

8.1.1 Setting the GRID FACTOR

•Calculation Formula

- 1) Elevation Factor

$$\text{Elevation Factor} = \frac{R}{R+ELEV.}$$

R : The average radius of the earth
 $ELEV.$: The elevation above mean sea level

- 2) Scale Factor

Scale Factor : Scale Factor at the surveying station

- 3) Grid Factor

Grid Factor = *Elevation Factor* × *Scale Factor*

Distance Calculation

- 1) Grid Distance

$$HDg = HD \times \text{Grid Factor}$$

HDg : Grid distance
 HD : Ground distance

- 2) Ground Distance

$$HD = \frac{HDg}{\text{Grid Factor}}$$

•How to Set Grid Factor

Operating procedure	Operation	Display
<p>1 Press the [F3](GRID FACTOR) key from the Layout menu 2/2.</p> <p>2 Press the [F3](YES) key.</p> <p>3 Enter Elevation. *1) Press the [F4](ENT) key.</p> <p>4 Enter Scale Factor in the same way. Grid Factor is displayed for 1 to 2 second and display returns to Layout menu 2/2.</p>	[F3]	<pre>LAYOUT 2/2 F1:SELECT A FILE F2:NEW POINT F3:GRID FACTOR P↓</pre>
	[F3]	<pre>GRID FACTOR =0.998843 >MODIFY? [YES] [NO]</pre>
	Enter ELEV. [F4]	<pre>GRID FACTOR ELEV.=1000 m SCALE:0.999000 --- --- [CLR] [ENT]</pre>
	Enter Scale [F4]	<pre>GRID FACTOR ELEV.:2000 m SCALE=1.001000 --- --- [CLR] [ENT]</pre> <pre>GRID FACTOR =1.000686</pre>
<p>*1) Refer to Section 2.5 “How to Enter Alphanumeric characters”.</p> <p>•Input Range :Elevation : –9,999 to +9,999 meter (–32,805 to +3,2805 ft, ft+in) Scale Factor : 0.990000 to 1.010000</p>		

8.1.2 Selecting Coordinate Data File

You can execute a Layout from selected coordinate data file, also you can record New point measured data into the selected coordinate data file.

•The only coordinate data file existing can be selected and you can not make a new file in this mode.

For more information about File, refer to Chapter 9 "MEMORY MANAGER MODE".

•When LAYOUT MODE is begun, a file can be selected in the same way.

Operating procedure	Operation	Display
<p>1 Press the [F1](SELECT A FILE) key from the Layout menu 2/2.</p> <p>2 Press the [F2](LIST) key to display the list of coordinate data file.*1)</p> <p>3 Scroll file list by pressing the [▲]or[▼] key and select a file to use. *2),3)</p> <p>4 Press the [F4](ENTER) key. The file will be set .</p>	[F1]	<pre>LAYOUT 2/2 F1:SELECT A FILE F2:NEW POINT F3:GRID FACTOR P↓</pre>
	[F2]	<pre>SELECT A FILE FN: _____ INPUT LIST --- ENTER</pre>
	[▲]or[▼]	<pre>COORDDATA /C0123 →*TOKBDATA /C0345 TOPCDATA /C0789 --- SRCH --- ENTER</pre>
	[F4]	<pre>*TOKBDATA /C0345 → TOPCDATA /C0789 SATIDATA /C0456 --- SRCH --- ENTER</pre> <pre>LAYOUT 2/2 F1:SELECT A FILE F2:NEW POINT F3:GRID FACTOR P↓</pre>
<p>*1) If you want to input file name directly, press the [F1](INPUT) key and enter a file name.</p> <p>*2) When a file has been selected already, "*" mark is indicated on left of current file name. For the file discrimination mark (*, @, &), refer to Section 9.3 "FILE MAINTENANCE".</p> <p>*3) Data in a file shown with arrow can be searched by pressing the [F2](SRCH) key.</p>		

8.1.3 Setting Occupied Point

Occupied point can be set by two setting methods as follows.

- 1) Setting from the coordinate data stored in the internal memory.
- 2) Direct key input of coordinate data.

•Example setting :Setting the occupied point from the internal coordinate data file

Operating procedure	Operation	Display
1 Press the [F1](OCC.PT INPUT) key from the Layout menu 1/2.	[F1]	OCC . PT PT# : _____ INPUT LIST NEZ ENTER
2 Press the [F1] (INPUT) key , enter PT# and press the [F4](ENT) key. *1)	[F1] Enter PT# [F4]	INSTRUMENT HEIGHT INPUT INS . HT= 0.000 m --- --- [CLR] [ENT]
3 Enter INS.HT in the same way. The display returns to layout menu 1/2.	Enter INS.HT [F4]	LAYOUT 1/2 F1 : OCC . PT INPUT F2 : BACKSIGHT F3 : LAYOUT P↓
*1) Refer to Section 2.5 “How to Enter Alphanumeric characters”.		

•Example setting :Setting Instrument point coordinates directly

Operating procedure	Operation	Display
1 Press the [F1](OCC.PT INPUT) key from the Layout menu 1/2.	[F1]	OCC . PT PT# : _____ INPUT LIST NEZ ENTER
2 Press the [F3] (NEZ) key.	[F3]	N→ 0.000 m E: 0.000 m Z: 0.000 m INPUT --- PT# ENTER
3 Press the [F1](INPUT) key and enter coordinate value. press the [F4](ENT) key. *1),2)	[F1] Enter coord. [F4]	COORD . DATA INPUT PT# : _____ INPUT --- --- ENTER
4 Press the [F1](INPUT) key and enter PT#. Press the [F4](ENT) key. *2)	[F1] Enter PT# [F4]	INSTRUMENT HEIGHT INPUT INS . HT= 0.000 m --- --- [CLR] [ENT]
5 Enter Instrument Height in the same way. The display returns to layout menu 1/2.	Enter INS.HT [F4]	LAYOUT 1/2 F1 : OCC . PT INPUT F2 : BACKSIGHT F3 : LAYOUT P↓
*1) Refer to Section 2.5 “How to Enter Alphanumeric characters”.		
*2) It is possible to record the coordinate value. Refer to Chapter 16 “SELECTING MODE”.		

8.1.4 Setting Backsight Point

The following three setting methods for Backsight point can be selected.

- 1) Setting from the coordinate data file stored in the internal memory.
- 2) Direct key input of coordinate data.
- 3) Direct key input of setting angle.

•Example setting :Setting the backsight point from the internal coordinate data file

Operating procedure	Operation	Display
1 Press the [F2](BACKSIGHT) key from the Layout menu 1/2.	[F2]	<pre>BACKSIGHT PT#: _____ INPUT LIST NE/AZ ENT</pre>
2 Press the [F1] (INPUT) key.	[F1]	<pre>BACKSIGHT PT#=BK-01 [ALP] [SPC] [CLR] [ENT]</pre>
3 Enter PT#, press the [F4](ENT) key. *1)	Enter PT# [F4]	<pre>BACKSIGHT H(B) = 0°00'00" >Sight ? [YES] [NO]</pre>
4 Sight the backsight point and press the [F3](YES) key. The display returns to the layout menu 1/2.	Sight BK [F3]	

*1) Refer to Section 2.6 "How to enter alphanumeric characters".

•With each pressing of [F3] key, method of inputting backsight is changed.

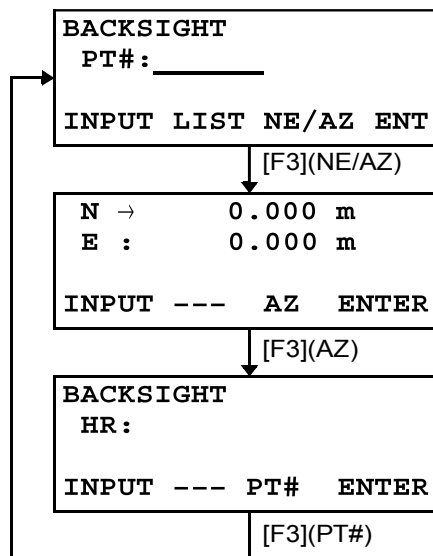

•Example setting: Setting the backsight point coordinates directly

Operating procedure	Operation	Display
<p>1 Press the [F2](BACKSIGHT) key from the Layout menu 1/2.</p>	<p>[F2]</p>	<pre>BACKSIGHT PT#: INPUT LIST NE/AZ ENT</pre>
<p>2 Press the [F3] (NE/AZ) key.</p>	<p>[F3]</p>	<pre>N→ 0.000 m E: 0.000 m INPUT --- AZ ENTER</pre>
<p>3 Press the [F1](INPUT) key and enter coordinate value. Press the [F4](ENT) key. *1) , 2)</p>	<p>[F1] Enter coord. [F4]</p>	<pre>BACKSIGHT H(B) = 0°00'00" >Sight ? [YES] [NO]</pre>
<p>4 Sight the backsight point.</p>	<p>Sight BK</p>	
<p>5 Press the [F3](YES) key. The display returns to the layout menu 1/2.</p>	<p>[F3]</p>	<pre>LAYOUT 1/2 F1:OCC.PT INPUT F2:BACKSIGHT F3:LAYOUT P↓</pre>
<p>*1) Refer to Section 2.5 "How to Enter Alphanumeric characters". *2) It is possible to record the coordinate value. Refer to Chapter 16 "SELECTING MODE".</p>		

8.2 Executing a Layout

The following methods can be selected for executing a Layout:

- 1) Recalling points from internal memory by point number.
- 2) Direct key input of coordinate values.

Example setting : Recalling point from internal memory.

Operating procedure	Operation	Display
		<pre>LAYOUT 1/2 F1:OCC.PT INPUT F2:BACKSIGHT F3:LAYOUT P↓</pre>
1 Press the [F3](LAYOUT) key from the layout menu 1/2.	[F3]	<pre>LAYOUT PT#: _____ INPUT LIST NEZ ENTER</pre>
2 Press the [F1](INPUT) key, and enter PT#. *1) Press the [F4](ENT) key. *2)	[F1] Enter PT# [F4]	<pre>REFLECTOR HEIGHT INPUT R.HT = 0.000 m --- --- [CLR] [ENT]</pre>
3 Enter reflector height in the same way. When the layout point is set, the instrument will start layout calculation. HR: Calculated horizontal angle of the layout point HD: Calculated horizontal distance from the instrument to the layout point	Enter R.HT [F4]	<pre>CALCULATED HR= 90°10'20" HD= 123.456 m ANGLE DIST --- ---</pre>
4 Collimate the prism, and press the [F1](ANGLE) key. PT#: Layout point HR: Measured (Actual) horizontal angle. dHR: Horizontal angle to be turned to the layout point = Actual horizontal angle - Calculated horizontal angle. Correct direction when dHR = 0°00'00"	Collimate P [F1]	<pre>PT#: LP-100 HR: 6°20'40" dHR: 23°40'20" DIST --- NEZ ---</pre>
5 Press the [F1](DIST) key. HD: Measuring (Actual) horizontal distance dHD: Horizontal distance to be turned to the layout point = Actual horizontal distance – Calculated horizontal distance. dZ: Vertical distance to be turned to the layout point = Actual vertical distance – Calculated vertical distance.	[F1]	<pre>HD* [t] < m dHD: m dZ: m MODE ANGLE NEZ NEXT</pre> <p style="text-align: center;">↓</p> <pre>HD* 143.84 m dHD: -13.34 m dZ: -0.05 m MODE ANGLE NEZ NEXT</pre>
6 Press the [F1](MODE) key. The fine mode measuring starts.	[F1]	<pre>HD* [r] < m dHD: m dZ: m MODE ANGLE NEZ NEXT</pre> <p style="text-align: center;">↓</p> <pre>HD* 156.835 m dHD: -3.327 m dZ: -0.046 m MODE ANGLE NEZ NEXT</pre>

7	When the display value dHR, dHD and dZ are equal to 0, the layout point is established.*3		
8	Press the [F3](NEZ) key. The coordinate data is shown.	[F3]	<pre> N * 100.000 m E : 100.000 m Z : 1.015 m MODE ANGLE --- NEXT </pre>
9	Press the [F4](NEXT) key to set next layout point . PT# is automatically incremented.	[F4]	<pre> LAYOUT PT#: LP-101 INPUT LIST NEZ ENTER </pre>
<p>*1) Refer to Section 2.5 "How to Enter Alphanumeric characters".</p> <p>*2) Point number could not be entered when data to comply with the coordinate value does not exist in the file.</p> <p>*3) Cut & Fill displaying function is available . Refer to Chapter 16 "SELECTING MODE".</p>			

8.2.1 Layout of Coordinates of Point to Line

The coordinate data of point to line can be used during execution of layout. When a point name including PTL coordinates (including 'From' and 'To' data) is specified, the mode will change to PTL mode automatically. There are two ways to enter the PTL coordinate data, Direct key input and Data transfer. Refer to 9.4.2 "PTL (Point to Line) data input" and 9.7 "Data Communications".

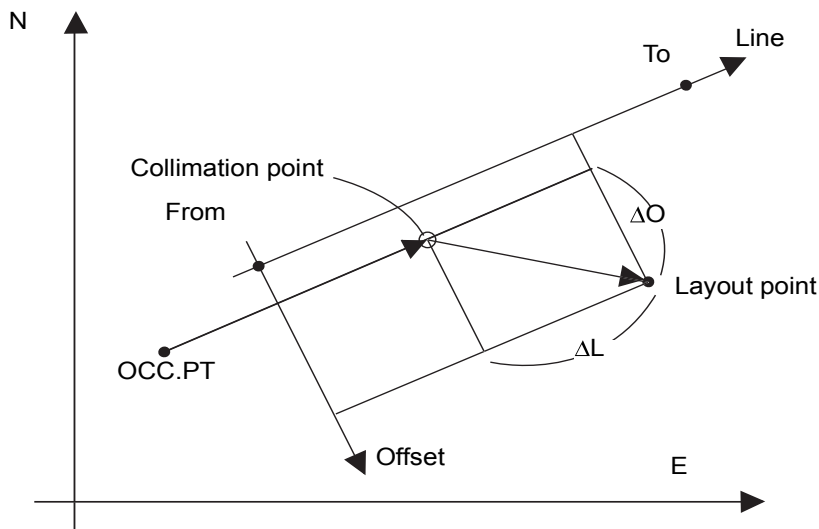

Operating procedure	Operation	Display
<p>1 Press the [F1](INPUT) key, and enter PT#. Press the [F4](ENT) key.</p> <p>2 Enter reflector height in the same way.</p> <p>When the layout point is set, the instrument will start layout calculation. The [F3](PTL) key will be assigned.</p> <p>3 Collimate the prism, and press the [F1](ANGLE) key.</p> <p>4 Press the [F1](DIST) key.</p> <p>HD: Measuring (Actual) horizontal distance dHD: Horizontal distance to be turned to the layout point = Actual horizontal distance – Calculated horizontal distance. dZ: Vertical distance to be turned to the layout point = Actual vertical distance – Calculated vertical distance.</p> <p>5 Press the [F2](PTL) key.</p> <p>The difference between Collimation point and Layout point distance on the coordinate system of the line determined will be displayed.</p>	[F1] Enter PT# [F4]	<pre>LAYOUT PT#: PT-21 INPUT LIST NEZ ENTER</pre>
	Enter R.HT [F4]	<pre>REFLECTOR HEIGHT INPUT R.HT : 1.500 m --- --- [CLR] [ENT]</pre>
	Collimate P [F1]	<pre>CALCULATED HR= 45°10'20" HD= 1.500 m ANGLE DIST PTL ---</pre>
	[F1]	<pre>PT#: LP-100 HR: 45°00'00" dHR: 0°00'00" DIST --- PTL ---</pre>
	[F2]	<pre>HD* 143.84 m dHD: -13.34 m dZ: -0.05 m MODE PTL NEXT</pre>
		<pre>dL: 0.005 m dO: 0.327 m dE: 0.046 m MODE ANGLE NEXT</pre>

8.3 Setting a New Point

New point is required for example when a layout point cannot be sighted from existing control points.

8.3.1 Side Shot Method

Set up the instrument at a known point, and measure the coordinate of the new points by the side shot method

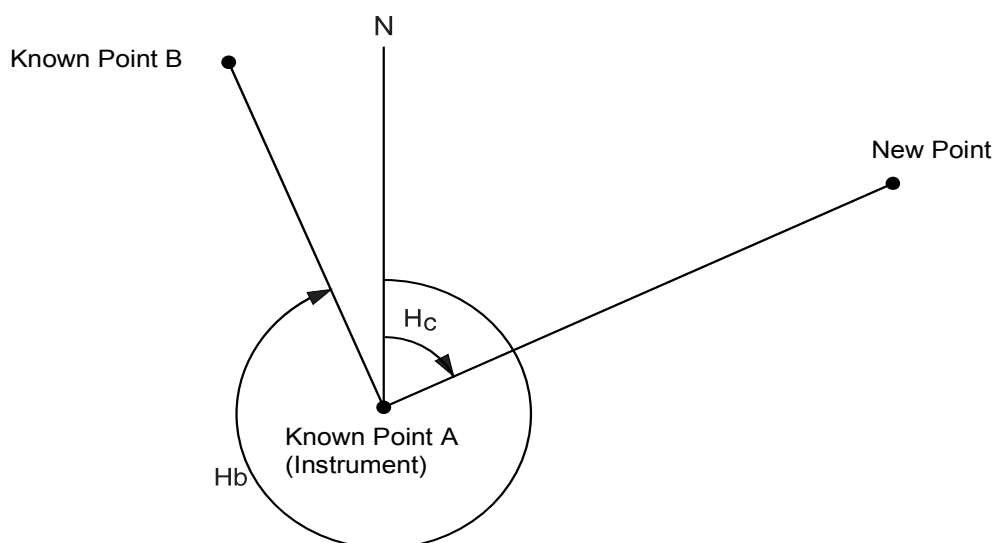

Operating procedure	Operation	Display
1 Press the [F4](↓) key from the layout menu 1/2 to get the layout menu 2/2.	[F4]	LAYOUT 1/2 F1:OCC.PT INPUT F2:BACKSIGHT F3:LAYOUT P↓
2 Press the [F2](NEW POINT).	[F2]	LAYOUT 2/2 F1:SELECT A FILE F2:NEW POINT F3:GRID FACTOR P↓
3 Press the [F1](SIDE SHOT) key.	[F1]	NEW POINT F1:SIDE SHOT F2:RESECTION
4 Press the [F2](LIST) key to display the list of coordinate data file. *1)	[F2]	SELECT A FILE FN: _____ INPUT LIST ----ENTER
5 Scroll file list by pressing [▲] or [▼] key and select a file to use. *2),3)	[▲] or [▼]	COORDDATA /C0123 →*TOKBDATA /C0345 TOPCDATA /C0789 --- SRCH --- ENTER
		*TOKBDATA /C0345 → TOPCDATA /C0789 SATIDATA /C0456 --- SRCH --- ENTER

<p>6 Press the [F4](ENTER) key. The file will be set .</p>	[F4]	<pre>SIDE SHOT PT#: _____ INPUT SRCH --- ENTER</pre>
<p>7 Press the [F1](INPUT) key, and enter the new point name. *4) Press the [F4](ENT) key.</p>	[F1] Enter PT# [F4]	<pre>REFLECTOR HEIGHT INPUT R.HT = 0.000 m --- --- [CLR] [ENT]</pre>
<p>8 Enter reflector height in the same way.</p>	Enter R.HT [F4]	<pre>REFLECTOR HEIGHT INPUT R.HT : 1.235 m >Sight ? [YES] [NO]</pre>
<p>9 Collimate the new point, and press the [F3](YES) key. Distance measuring starts.</p>	Collimate [F3]	<pre>HR: 123°40'20" HD* [n] < m VD: m > Measuring... < complete ></pre>
<p>10 Press the [F3](YES) key.*5) The name and coordinate value are stored into COORD.DATA. The input menu for next new point is displayed. PT# is automatically incremented.</p>	[F3]	<pre>N : 1234.567 m E : 123.456 m Z : 1.234 m >REC ? [YES] [NO]</pre> <p style="text-align: center;">↓</p> <pre>SIDE SHOT PT#:NP-101 INPUT SRCH --- ENTER</pre>
<p>*1) If you want to input file name directly, press the [F1](INPUT) key and enter a file name. *2) When a file has been selected already, "*" mark is indicated on left of current file name. For the file discrimination mark (*, @, &), refer to Chapter 9.3 "FILE MAINTENANCE". *3) Data in a file shown with arrow can be searched by pressing [F2](SRCH) key. *4) Refer to Section 2.5 "How to Enter Alphanumeric characters". *5) An error will be displayed when the internal memory is full.</p>		

8.3.2 Resection Method

Set up the instrument at a new point, and calculate the coordinate of the new point using the coordinate data of maximum seven known points and the measurements made to these points.

By following observation, resection is possible.

- Resection by distance measurement: 2 or more points must be measured
- Resection by angle measurement only: 3 or more points must be measured

An occupied point coordinate value will be calculated by the method of least squares.

(In case that 3 known points are measured by angle measurement only, the value would not be calculated by the method of least squares.)

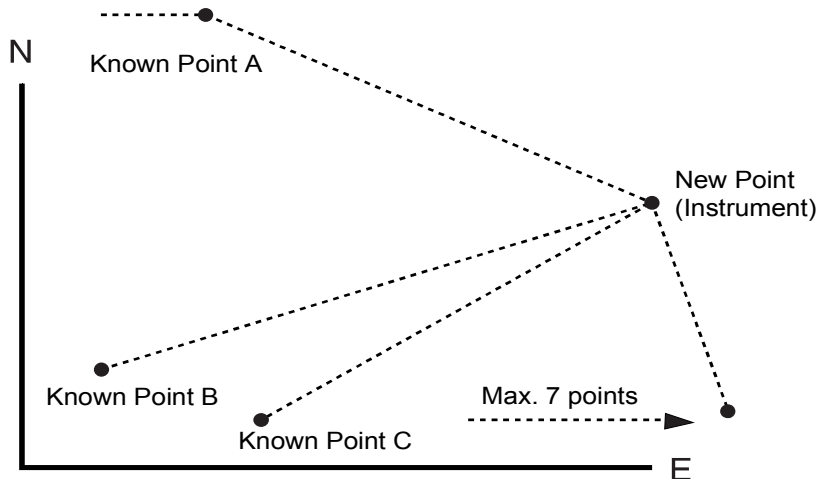

Operating procedure	Operation	Display
<p>1 Press the [F4](↓) key from the layout menu 1/2 to get the layout menu 2/2.</p> <p>2 Press the [F2](NEW POINT).</p> <p>3 Press the [F2](RESECTION) key.</p> <p>4 Press the [F1](INPUT) key, and enter the new point name. *1) ,2) Press the [F4](ENT) key.</p>	[F4]	<pre>LAYOUT 1/2 F1:OCC.PT INPUT F2:BACKSIGHT F3:LAYOUT P↓</pre>
	[F2]	<pre>LAYOUT 2/2 F1:SELECT A FILE F2:NEW POINT F3:GRID FACTOR P↓</pre>
	[F2]	<pre>NEW POINT F1:SIDE SHOT F2:RESECTION</pre>
	[F1] Enter PT# [F4]	<pre>NEW POINT PT#: _____ INPUT SRCH SKP ENTER</pre> <pre>INSTRUMENT HEIGHT INPUT INS.HT = 0.000 m --- --- [CLR] [ENT]</pre>

5 Enter instrument height in the same way.

Enter
INS.HT
[F4]

```
NO01#
PT#: _____
INPUT LIST NEZ ENTER
```

6 Enter the known point A number. *3)

[F1]
Enter PT#
[F4]

```
REFLECTOR HEIGHT
INPUT
R.HT = 0.000 m
--- --- [CLR] [ENT]
```

7 Enter reflector height.

Enter R.HT
[F4]

```
REFLECTOR HEIGHT
INPUT
R.HT : 1.235 m
>Sight ? ANG DIST
```

8 Collimate the known point A, and press the [F3](ANG) or [F4](DIST) key.
Example:[F4](DIST)
Distance measuring starts.

Collimate A
[F4]

```
HR: 123°40'20"
HD* < m
VD: m
> Measuring...
< complete >
```

Known point B entering display will be shown.

```
NO02#
PT#: _____
INPUT LIST NEZ ENTER
```

9 Same as procedure **6** to **8** proceed to the known point B.

When two points have been measured by the [F4](DIST) key, the RESIDUAL ERROR will be calculated. *4)

```
SELECT GRID FACTOR
F1:USE LAST DATA
F2:CALC MEAS.DATA
```

10 Select GRID FACTOR for calculation of RESIDUAL ERROR by pressing [F1] or [F2] key. *5)
Example: [F1]

[F1]

```
RESIDUAL ERROR
dHD= 0.015 m
dZ = 0.005 m
NEXT --- G.F CALC
```

11 Press the [F1](NEXT) key to measure other points. Maximum seven points can be measured.

[F1]

```
NO03#
PT#: _____
INPUT LIST NEZ ENTER
```

12 Same as procedure **6** to **8** proceed to the known point C.

```
HR: 123°40'20"
HD* < m
VD: m
> Measuring...
< complete >
```

```
HR: 123°40'20"
HD: 123.456 m
VD: 1.234 m
NEXT --- --- CALC
```

<p>13 Press the [F4](CALC) key. *6) Standard Deviation will be shown. Unit : (sec.) or (mGON) or (mMIL)</p>	[F4]	<table border="1"> <tr><td colspan="2">Standard Deviation</td></tr> <tr><td>=</td><td>1.23 sec.</td></tr> <tr><td>---</td><td>↓</td></tr> <tr><td>---</td><td>NEZ</td></tr> </table>	Standard Deviation		=	1.23 sec.	---	↓	---	NEZ		
Standard Deviation												
=	1.23 sec.											
---	↓											
---	NEZ											
<p>14 Press the [F2](↓) key. Standard Deviations of each coordinate will be shown. Unit : (mm) or (inch) The display will be changed alternately by pressing [F2](↓) or (↑) key.</p>	[F2]	<table border="1"> <tr><td>SD (n) :</td><td>1.23 mm</td></tr> <tr><td>SD (e) :</td><td>1.23 mm</td></tr> <tr><td>SD (z) :</td><td>1.23 mm</td></tr> <tr><td>---</td><td>↑</td></tr> <tr><td>---</td><td>NEZ</td></tr> </table>	SD (n) :	1.23 mm	SD (e) :	1.23 mm	SD (z) :	1.23 mm	---	↑	---	NEZ
SD (n) :	1.23 mm											
SD (e) :	1.23 mm											
SD (z) :	1.23 mm											
---	↑											
---	NEZ											
<p>15 Press the [F4](NEZ) key. Coordinate data of the new point will be shown.</p>	[F4]	<table border="1"> <tr><td>N :</td><td>65.432 m</td></tr> <tr><td>E :</td><td>876.543 m</td></tr> <tr><td>Z :</td><td>1.234 m</td></tr> <tr><td>>REC ?</td><td>[YES] [NO]</td></tr> </table>	N :	65.432 m	E :	876.543 m	Z :	1.234 m	>REC ?	[YES] [NO]		
N :	65.432 m											
E :	876.543 m											
Z :	1.234 m											
>REC ?	[YES] [NO]											
<p>16 Press the [F3](YES) key. *7) The new point data will be stored into the coordinate data file and the value of occupied coordinate data will change to that of the calculated NEW POINT.</p>	[F3]	<table border="1"> <tr><td colspan="2">NEW POINT</td></tr> <tr><td>F1:</td><td>SIDE SHOT</td></tr> <tr><td>F2:</td><td>RESECTION</td></tr> </table>	NEW POINT		F1:	SIDE SHOT	F2:	RESECTION				
NEW POINT												
F1:	SIDE SHOT											
F2:	RESECTION											

The display returns to new point menu.

- *1) Refer to Section 2.5 "How to Enter Alphanumeric characters".
- *2) When there is no need to memorize the new point data, press the [F3](SKP) key.
- *3) To enter the known point coordinate data by direct key inputting, press the [F3](NEZ) key.
- *4) RESIDUAL ERROR;
dHD (Horizontal distance between two known points) = Measured value – Calculated value
dZ=(Z coordinate of the new point calculated from known point A) – (Z coordinate of the new point calculated from known point B)
- *5) [F1:USE LAST DATA]; RESIDUAL ERROR is calculated with GRID FACTOR already set.
[F2:CALC MEAS.DATA]; RESIDUAL ERROR is calculated without GRID FACTOR already set. In this case, new GRID FACTOR is calculated from measured data and reset."
•To see the GRID FACTOR value, press the [F3](G.F.) key.
- *6) In case that the all points are measured by angle measurement only, the following display will be shown. You can select Z coordinate calculation.

CALC. Z COORD.	
F1:	YES
F2:	NO

F1(YES) : :N,E,Z coordinates will be calculated with measured angle data.
F2(NO) : :N and E coordinates will be calculated with measured horizontal angle data. Z coordinate would not be calculated.
(Z coordinate value =0.000m)

When the distance measurement is done even one point, Z coordinate will be calculated as a mean value of relative distance (vertical distance data).

*7) The display shows ">SET ?" when [F3](SKP) key pressed in step 4. In this case, the new point data is not stored into the coordinate data file, only the value of occupied coordinate data changes to that of the calculated NEW POINT.

1 Viewing PT# LIST

You can see the PT# List and enter the data from the List, also you can see coordinate data of a point.
 [Example: Executing Layout Mode]

Operating procedure	Operation	Display
<p>1 While executing the LAYOUT mode, press the [F2](LIST) key. The arrow(→) indicates selected data.</p> <p>2 By pressing the following keys, the list will increase or decrease. [▲]or[▼]: Increasing or Decreasing one by one. [▶]or[◀] :By ten Increasing or Decreasing.</p> <p>3 To show the coordinate of the selected data, press the [F1](VIEW) key. It is still possible to scroll the PT# data by pressing [[▲]or[▼] key.</p> <p>4 Press the [ESC] key. The display returns to the List.</p> <p>5 Press the [F4] (ENTER) key. The selected point number is set as PT#.</p>	<p>[F2]</p> <p>[▲]or[▼], [▶]or[◀]</p> <p>[F1]</p> <p>[ESC]</p> <p>[F4]</p>	<pre>LAYOUT PT#: _____ INPUT LIST NEZ ENTER →DATA-01 DATA-02 VIEW SRCH --- ENTER DATA-49 →DATA-50 DATA-51 VIEW SRCH --- ENTER PT# DATA-50 N] 100.234 m E] 12.345 m Z] 1.678 m DATA-49 →DATA-50 DATA-51 VIEW SRCH --- ENTER REFLECTOR HEIGHT INPUT R.HT = 0.000 m --- --- [CLR] [ENT]</pre>
<p>• The operation of [F2](SRCH) is same as the "SEARCH" in the MEMORY MANAGER MODE. For more information, refer to Chapter 9 "MEMORY MANAGER MODE".</p>		

9 MEMORY MANAGER MODE

The following items for internal memory are available in this mode.

- 1) FILE STATUS : Checking the number of stored data / Remaining internal memory capacity.
- 2) SEARCH : Searching the recorded data.
- 3) FILE MAINTAN. : Deleting files / Editing file name
- 4) COORD. INPUT : Inputting coordinate data into Coord. data file.
- 5) DELETE COORD. : Deleting coordinate data from Coord. data file.
- 6) PCODE INPUT : Inputting PCODE DATA into PCODE Library
- 7) DATA TRANSFER : Sending measured data or coordinate data or PCODE Library data / Uploading coordinate data or PCODE Library data / Setting communication parameters
- 8) INITIALIZE : Initializing internal memory.

•Memory manager menu operation

By pressing the [MENU] key, the instrument will be in MENU 1/3 mode.

Press the [F3](MEMORY MGR.) key, the menu of MEMORY MGR. 1/3 will be shown.

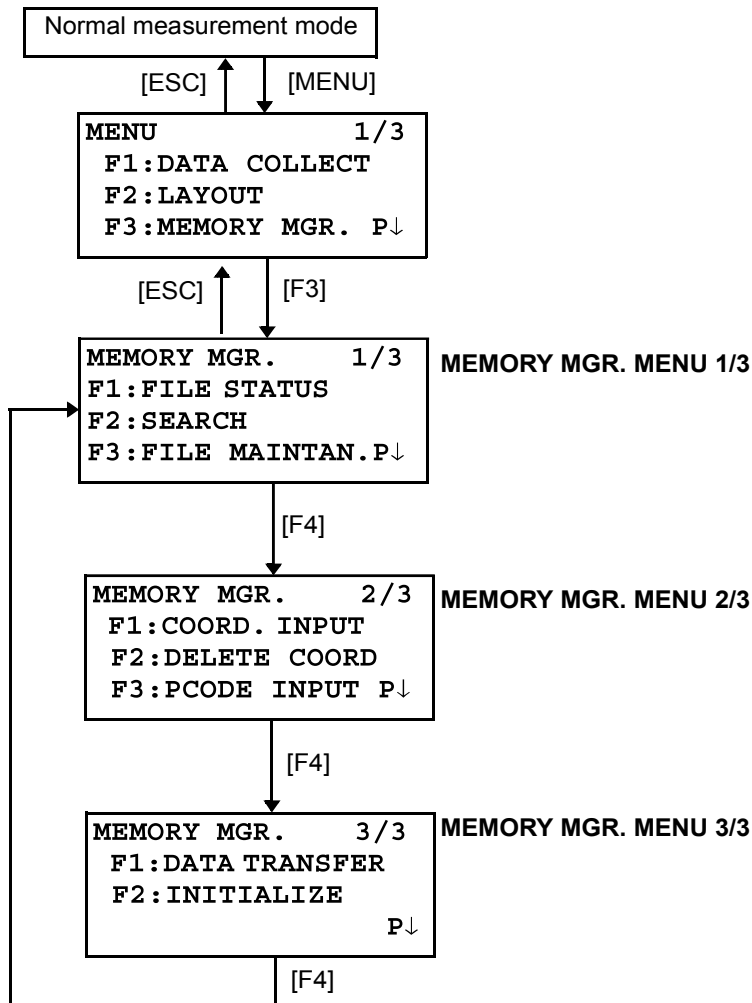

9.1 Display Internal Memory Status

This mode is used to check the internal memory status.

Operating procedure	Operation	Display
<p>1 Press the [F3](MEMORY MGR.) key from the menu 1/3.</p>	<p>[F3]</p>	<pre> MEMORY MGR. 1/3 F1:FILE STATUS F2:SEARCH F3:FILE MAINTAN P↓ </pre>
<p>2 Press the [F1](FILE STATUS) key.</p> <p>The total number of stored measured data files and coordinate files are shown.</p>	<p>[F1]</p>	<pre> FILE STATUS 1/2 MEAS. FILE : 3 COORD. FILE: 6 [.....] P↓ </pre>
<p>3 Press the [F4](P↓) key.</p> <p>The total number of stored measured data and coordinate data in all files are shown.*1)</p>	<p>[F4]</p>	<p style="text-align: center;">↑ Remaining memory capacity</p> <pre> DATA STATUS 2/2 MEAS. DATA :0100 COORD. DATA:0050 [.....] P↓ </pre>
<p>*1) Each coordinate file has one extra data for working area. •The FILE/DATA STATUS display will change alternately by pressing [F4](P↓) key. •To return to MEMORY MGR. menu press the [ESC] key.</p>		

9.2 Searching Data

This mode is used to search the recorded file data in the DATA COLLECT or LAYOUT mode. The following 3 search methods in each type of files can be selected.

- 1: First data search
- 2: Last data search
- 3: Point number search(MEAS.DATA, COORD.DATA)
Number search (PCODE LIB.)

MEAS. DATA : Measured data in the data collect mode.

COORD. DATA : Coordinate data for layout, control points and new point data measured in the layout mode.

PCODE LIB. : The data which was registered with a number from 1 to 50 in Point code library. Point name (PT#, BS#), ID, PCODE and Height data (INS.HT, R.HT) can be corrected in the searching mode.

Measured value can not be corrected.

9.2.1 Measured Data Searching

Example :Point number searching

Operating procedure	Operation	Display
1 Press the [F3](MEMORY MGR.) key from the menu 1/3.	[F3]	<pre> MEMORY MGR. 1/3 F1:FILE STATUS F2:SEARCH F3:FILE MAINTAN P↓ </pre>
2 Press the [F2](SEARCH) key.	[F2]	<pre> SEARCH F1:MEAS. DATA F2:COORD. DATA F3:PCODE LIB. </pre>
3 Press the [F1](MEAS. DATA) key.	[F1]	<pre> SELECT A FILE FN: _____ INPUT LIST --- ENTER </pre>
4 Press the [F1](INPUT) key and enter File Name. Press the [F4](ENT) key. *1),2)	[F1] Enter FN [F4]	<pre> MEAS. DATA SEARCH F1:FIRST DATA F2:LAST DATA F3:PT# DATA </pre>
5 Press the [F3](PT# DATA) key.	[F3]	<pre> PT# DATA SEARCH PT#: _____ INPUT --- --- ENTER </pre>
6 Press the [F1](INPUT) key and enter PT#. Press the [F4](ENT) key. *1)	[F1] Enter PT# [F4]	<pre> PT# TOP-104 2/2 V 98°36'20" HR 160°40'20" TILT 0°00'00" ↓ </pre>
7 Press the [F4](↓) key to scroll data for selected point.	[F4]	<pre> PT# TOP-104 1/2 PCODE R.HT 1.200 m EDIT ↓ </pre>
<p>*1) Refer to Section 2.6 "How to enter alphanumeric characters". *2) To show the file list, press the [F2](LIST) key. •" " represents data shown on the display is the stored data. •Press the [▲] or [▼] key to scroll to next or previous point. •To search MEAS. DATA of the same point number, press[◀]or[▶] key.</p>		

•To edit the data in searching mode

Point name (PT#, BS#) , ID, PCODE and Height data (INS.HT, R.HT) can be corrected in the searching mode.

Measured value can not be corrected.

Operating procedure	Operation	Display
<p>1 Press the [F1](EDIT) key from last page of displayed data.</p>	<p>[F1]</p>	<pre>PT#]TOP-104 2/2 PCODE] R.HT] 1.000 m EDIT ↓</pre>
<p>2 Select the item to correct by pressing [▲]or[▼] key.</p>	<p>[▲]or[▼]</p>	<pre>PT# →TOP-104 PCODE : R.HT : 1.000 m INPUT --- --- ENTER</pre>
<p>3 Press the [F1](INPUT) key and enter data. *1) Press the [F4](ENT) key.</p>	<p>[F1] Enter Data</p>	<pre>PT# :TOP-104 PCODE : R.HT → 1.000 m INPUT --- --- ENTER</pre>
<p>4 Press the [F4](ENTER) key.</p>	<p>[F4] [F4]</p>	<pre>PT# →TOP-104 PCODE : R.HT : 1.200 m >SAVE? [YES] [NO]</pre>
<p>5 Press the [F3](YES) key .</p>	<p>[F3]</p>	<pre>PT#]TOP-104 2/2 PCODE] R.HT] 1.200 m EDIT ↓</pre>
<p>*1) Refer to Section 2.5 “How to Enter Alphanumeric characters”. •When editing, ID and PCODE are not linked with PCODE LIBRARY. •Even though the height data (INS.HT, R.HT) are corrected, the measured value can not be corrected.</p>		

9.2.2 Coordinate Data Searching

Example searching :Point number searching

Operating procedure	Operation	Display
1 Press the [F3](MEMORY MGR.) key from the menu 1/3.	[F3]	<pre> MEMORY MGR. 1/3 F1:FILE STATUS F2:SEARCH F3:FILE MAINTAN P↓ </pre>
2 Press the [F2](SEARCH) key.	[F2]	<pre> SEARCH F1:MEAS. DATA F2:COORD. DATA F3:PCODE LIB. </pre>
3 Press the [F2](COORD. DATA) key.	[F2]	<pre> SELECT A FILE FN: _____ INPUT LIST --- ENTER </pre>
4 Press the [F1](INPUT) key and enter File Name. Press the [F4](ENT) key. *1)	[F1] Enter FN [F4]	<pre> COORD. DATA SEARCH F1:FIRST DATA F2:LAST DATA F3:PT# DATA </pre>
5 Press the [F3](PT# DATA) key.	[F3]	<pre> PT# DATA SEARCH PT#: _____ INPUT --- --- ENTER </pre>
6 Press the [F1](INPUT) key and enter PT#. Press the [F4](ENT) key. *1)	[F1] Enter PT# [F4]	<pre> PT#]TOP-104 1/2 N] 100.234 m E] 12.345 m Z] 1.678 m ↓ </pre>
7 Press the [F4](↓) key to get the next page.	[F4]	<pre> PCODE] TOPS 2/2 STR.] ↓ </pre>

- *1) Refer to Section 2.5 "How to Enter Alphanumeric characters".
- "]" represents data shown on the display is the stored data.
- Press the [▲] or [▼] key to scroll to next or previous point.
- To search COORD. DATA of the same point number, press the [◀] or [▶] key.
- PTL data will be shown below.

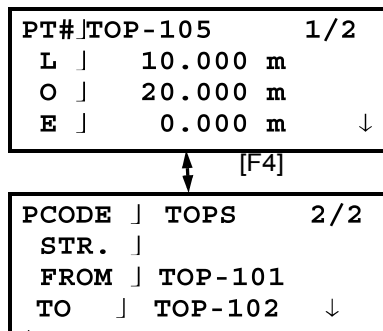

9.2.3 PCODE LIBRARY Searching

Example searching :Number searching

Operating procedure	Operation	Display
<p>1 Press the [F3](MEMORY MGR.) key from the menu 1/3.</p>	<p>[F3]</p>	<pre>MEMORY MGR. 1/3 F1:FILE STATUS F2:SEARCH F3:FILE MAINTAN P↓</pre>
<p>2 Press the [F2](SEARCH) key.</p>	<p>[F2]</p>	<pre>SEARCH F1:MEAS. DATA F2:COORD. DATA F3:PCODE LIB.</pre>
<p>3 Press the [F3](PCODE LIB.) key.</p>	<p>[F3]</p>	<pre>PCODE DATA SEARCH F1:FIRST DATA F2:LAST DATA F3:No. SEARCH</pre>
<p>4 Press the [F3](No. SEARCH) key.</p>	<p>[F3]</p>	<pre>PCODE No. SEARCH No.= --- --- [CLR] [ENT]</pre>
<p>5 Enter number.Press the [F4](ENT) key. *1) The number and linked data will be shown. *2)</p>	<p>Enter PT# [F4]</p>	<pre>011:NAKADAI →012:HILLTOP 013:ITABASH EDIT --- CLR ---</pre>
<p>*1) Refer to Section 2.5 “How to Enter Alphanumeric characters”. •Press the [▲] or [▼] key to scroll to next or previous PCODE data. *2) To correct the PCODE data , press the [F1](EDIT) key. To delete the PCODE data, press the [F3](CLR) key.</p>		

9.3 FILE MAINTENANCE

In this mode, the following items are available.

Renaming file name / Searching data in a file / Deleting files

•**FILE MAINTAN.** menu

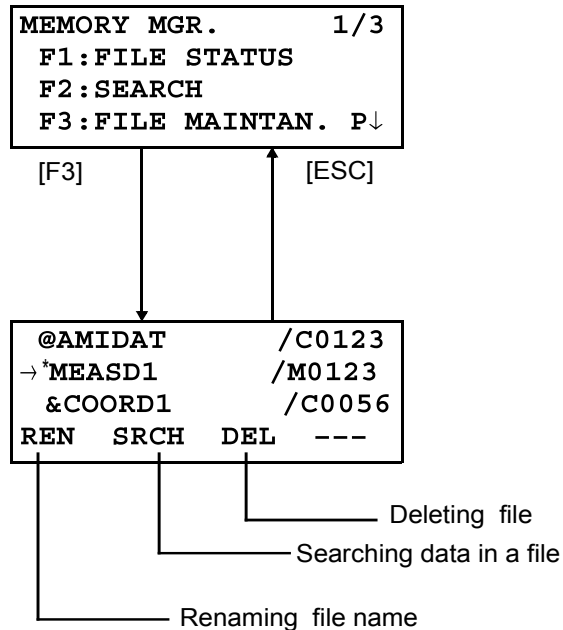

Pressing [F3](FILE MAINTAN.) key from MEMORY MANAGER menu 1/3, file list will be shown.

- File discrimination mark (*,@,&)
 - File discrimination mark (*,@,&) placed before file name indicates the file status.
 - For measured data file
 - “ * ” :selected file for DATA COLLECT mode.
 - For coordinate data file
 - “ * ” :selected coordinate file for LAYOUT mode.
 - “ @ ” :selected coordinate file for DATA COLLECT mode.
 - “ & ” :selected coordinate file for both LAYOUT and DATA COLLECT mode.
 - Data discrimination character (M, C)
 - Data discrimination character (M, C) placed before four figures indicates the type of data.
 - “ M ” :Measured data
 - “ C ” :Coordinate data.
 - Four figures means the total number of data in the file.
 - (Coordinate data file has an extra data for working.)
- Press the [▲] or [▼] key to scroll to next file.

9.3.1 Rename a File

An existing file in internal memory can be renamed.

Operating procedure	Operation	Display
1 Press the [F3](FILE MAINTAN.) key from the Memory manager menu 1/3.	[F3]	<pre> →MEASD1 /M0123 COORD1 /C0056 REN SRCH DEL --- </pre>
2 Select a file by pressing [▲]or[▼] key.	[▲]or[▼]	<pre> MEASD1 /M0123 →COORD1 /C0056 COORD2 /C0098 REN SRCH DEL --- </pre>
3 Press the [F1](REN) key.	[F1]	<pre> MEASD1 /M0123 =COORD1 /C0056 COORD1 /C0098 [ALP] [SPC] [CLR] [ENT] </pre>
4 Enter new file name. Press the [F4](ENT) key. *1)	Enter FN [F4]	<pre> MEASD1 /M0123 →COORD5 /C0056 COORD1 /C0098 REN SRCH DEL --- </pre>
<p>*1) Refer to Section 2.5 "How to Enter Alphanumeric characters". Existing file name can not be available. To return to the FILE MAINTAN. Menu , press the [ESC] key.</p>		

9.3.2 Searching Data in a File

An existing file in internal memory can be searched.

Operating procedure	Operation	Display
1 Press the [F3](FILE MAINTAN.) key from the Memory manager menu 1/3.	[F3]	<pre> →MEASD1 /M0123 COORD1 /C0056 REN SRCH DEL --- </pre>
2 Select a file to search by pressing [▲]or[▼] key.	[▲]or[▼]	<pre> MEASD1 /M0123 →COORD1 /C0056 COORD2 /C0098 REN SRCH DEL --- </pre>
3 Press the [F2](SRCH) key.	[F2]	<pre> SEARCH [COORD1] F1:FIRST DATA F2:LAST DATA F3:PT# DATA </pre>
4 Select searching method by pressing the [F1] to [F3] key. *1)	[F1] to [F3]	
<p>*1) Because procedures from next are same as procedures of Section 9.2 "Searching Data", refer to Section 9.2 "Searching Data" To return to the FILE MAINTAN. Menu , press the [ESC] key.</p>		

9.3.3 Deleting a File

This mode erases a file from internal memory. Only one file can be erased at a time.

Operating procedure	Operation	Display
1 Press the [F3](FILE MAINTAN.) key from the Memory manager menu 1/3.	[F3]	<pre> →MEASD1 /M0123 COORD1 /C0056 REN SRCH DEL --- </pre>
2 Select a file to delete by pressing [▲]or[▼] key.	[▲]or[▼]	<pre> MEASD1 /M0123 →COORD1 /C0056 COORD2 /C0098 REN SRCH DEL --- </pre>
3 Press the [F3](DEL) key.	[F3]	<pre> MEASD1 /M0123 →COORD1 /C0056 COORD2 /C0098 >DELETE? [NO] [YES] </pre>
4 Confirm the deleting, and press the [F4](YES) key.	[F4]	<pre> MEASD1 /M0123 →COORD2 /C0098 COORD3 /C0321 REN SRCH DEL --- </pre>
•To return to the FILE MAINTAN. Menu , press the [ESC] key.		

9.4 Coordinate Data Direct Key Input

9.4.1 Coordinate data input

Coordinate data for the layout point or control point can be input directly from the keyboard. This data can be stored into a file in the internal memory.

Operating procedure	Operation	Display
1 Press the [F3](MEMORY MGR.) key from the menu 1/3.	[F3]	<pre> MEMORY MGR. 1/3 F1:FILE STATUS F2:SEARCH F3:FILE MAINTAN P↓ </pre>
2 Press the [F4](P↓) key.	[F4]	<pre> MEMORY MGR. 2/3 F1:COORD. INPUT F2:DELETE COORD. F3:PCODE INPUT P↓ </pre>
3 Press the [F1](COORD. INPUT) key.	[F1]	<pre> SELECT A FILE FN: _____ INPUT LIST --- ENTER </pre>
4 Press the [F1](INPUT) key and enter File Name you want to input. Press the [F4](ENT) key. *1)	[F1] Enter FN [F4]	<pre> COORD. DATA INPUT F1:NEZ F2:PTL </pre>
5 Select the kind of coordinates. NEZ: Coordinate data PTL: The coordinate data for point to line	[F1]	<pre> COORD. DATA INPUT PT#: _____ INPUT --- --- ENTER </pre>
6 Press the [F1](INPUT) key and enter PT#. Press the [F4](ENT) key. *1)	[F1] Enter PT# [F4]	<pre> N→ 100.234 m E: 12.345 m Z: 1.678 m INPUT --- --- ENTER </pre>
7 Enter Coordinate data. Press the [F4](ENT) key. *1)	Enter data [F4]	<pre> COORD. DATA INPUT PCODE: _____ INPUT LIST --- ENTER </pre>
8 Enter PCODE and press the [F4](ENTER). Next input display is shown, point number (PT#) is automatically incremented.	[F1] Enter PCODE [F4]	<pre> COORD. DATA INPUT PT#:geo-FENNEL INPUT --- --- ENTER </pre>

*1) Refer to Section 2.5 "How to Enter Alphanumeric characters".

9.4.2 PTL (Point to Line) data input

PTL Coordinate data for the layout point or control point can be input directly from the keyboard. This data can be stored into a file in the internal memory.

Operating procedure	Operation	Display
<p>1 Press the [F3](MEMORY MGR.) key from the menu 1/3.</p>	<p>[F3]</p>	<pre> MEMORY MGR. 1/3 F1:FILE STATUS F2:SEARCH F3:FILE MAINTAN P↓ </pre>
<p>2 Press the [F4](P↓) key.</p>	<p>[F4]</p>	<pre> MEMORY MGR. 2/3 F1:COORD. INPUT F2:DELETE COORD. F3:PCODE INPUT P↓ </pre>
<p>3 Press the [F1](COORD. INPUT) key.</p>	<p>[F1]</p>	<pre> SELECT A FILE FN: _____ INPUT LIST --- ENTER </pre>
<p>4 Press the [F1](INPUT) key and enter File Name you want to input. Press the [F4](ENT) key. *1)</p>	<p>[F1] Enter FN [F4]</p>	<pre> COORD. DATA INPUT F1:NEZ F2:PTL </pre>
<p>5 Select the kind of coordinates. NEZ: Coordinate data PTL: The coordinate data for point to line</p>	<p>[F2]</p>	<pre> COORD. DATA INPUT PT#: _____ INPUT --- --- ENTER </pre>
<p>6 Press the [F1](INPUT) key and enter PT#. Press the [F4](ENT) key. *1)</p>	<p>[F1] Enter PT# [F4]</p>	<pre> L→ m O: m E: m INPUT --- --- ENTER </pre>
<p>7 Enter PTL data. Press the [F4](ENT) key. *1) L: Line O: Offset E: Elevation Enter PCODE , FROM and TO data and press the [F4](ENTER). *2) Next input display is shown, point number (PT#) is automatically incremented.</p>	<p>Enter data [F4] [F1] Enter PCODE [F4]</p>	<pre> PCODE→ _____ FROM: _____ TO : _____ INPUT LIST --- ENTER </pre> <pre> COORD. DATA INPUT PT#: geo-FENNEL INPUT --- --- ENTER </pre>
<p>*1) Refer to Section 2.5 "How to Enter Alphanumeric characters". *2) When the inputted point name data as FROM or TO, does not exist in the same file, an error will be displayed.</p>		

9.5 Delete a Coordinate Data from a File

Coordinate data in a file can be erased.

Operating procedure	Operation	Display
1 Press the [F3](MEMORY MGR.) key from the menu 1/3.	[F3]	<pre> MEMORY MGR. 1/3 F1:FILE STATUS F2:SEARCH F3:FILE MAINTAN P↓ </pre>
2 Press the [F4](P↓) key.	[F4]	<pre> MEMORY MGR. 2/3 F1:COORD. INPUT F2:DELETE COORD. F3:PCODE INPUT P↓ </pre>
3 Press the [F2](DELETE COORD.) key.	[F2]	<pre> SELECT A FILE FN: _____ INPUT LIST --- ENTER </pre>
4 Press the [F1](INPUT) key and enter File Name. Press the [F4](ENT) key. *1)	[F1] Enter FN [F4]	<pre> DELETE COORD. PT#: _____ INPUT LIST --- ENTER </pre>
5 Press the [F1](INPUT) key and enter PT#. Press the [F4](ENT) key. *1)	[F1] Enter PT# [F4]	<pre> N: 100.234 m E: 12.345 m Z: 1.678 m >DELETE? [YES] [NO] </pre>
6 Confirm the data and press the [F3](YES) key. Deleting starts. The display will return to the previous display.	[F3]	
*1) Refer to Section 2.5 "How to Enter Alphanumeric characters".		

9.6 Editing PCODE Library

PCODE data can be entered into PCODE Library in this mode.

A PCODE is linked with a number of 1 to 50

PCODE can be also edited in DATA COLLECT menu 2/3 in the same way.

Operating procedure	Operation	Display
1 Press the [F3](MEMORY MGR.) key from the menu 1/3.	[F3]	<pre> MEMORY MGR. 1/3 F1:FILE STATUS F2:SEARCH F3:FILE MAINTAN. P↓ </pre>
2 Press the [F4](P↓) key.	[F4]	<pre> MEMORY MGR. 2/3 F1:COORD. INPUT F2:DELETE COORD. F3:PCODE INPUT P↓ </pre>
3 Press the [F3](PCODE INPUT) key.	[F3]	<pre> →001:geo-FENNEL 002:TOKYO EDIT --- CLR --- </pre>
4 By pressing the following keys, the list will increase or decrease. [▲]or[▼]:Increasing or Decreasing one by one [▶]or[◀]:By ten Increasing or Decreasing.	[▲]or[▼], [▶]or[◀]	<pre> 011:URAH →012:AMIDAT 013:HILLTO EDIT --- CLR --- </pre>
5 Press the [F1](EDIT) key.	[F1]	<pre> 011:URAH →012=AMIDAT 013:HILLTO [ALP] [SPC] [CLR] [ENT] </pre>
6 Enter PCODE and press the [F4](ENT) key. *1)	Enter PCODE [F4]	<pre> 011:URAH →012:AMISUN 013:HILLTO EDIT --- CLR --- </pre>
*1) Refer to Section 2.5 "How to Enter Alphanumeric characters".		

9.7 Data Communications

You can send a data file stored in the internal memory to a computer directly. Also, you can directly load a coordinate data file and PCODE Library data to the internal memory from the computer.

9.7.1 Sending Data

Example: Sending a Measured data file

Operating procedure	Operation	Display
1 Press the [F3](MEMORY MGR.) key from the menu 1/3.	[F3]	<pre> MEMORY MGR. 1/3 F1:FILE STATUS F2:SEARCH F3:FILE MAINTAN P↓ </pre>
2 Press the [F4](P↓) key twice.	[F4] [F4]	<pre> MEMORY MGR. 3/3 F1:DATA TRANSFER F2:INITIALIZE P↓ </pre>
3 Press the [F1](DATA TRANSFER) key .	[F1]	<pre> DATA TRANSFER F1:GTS FORMAT F2:SSS FORMAT </pre>
4 Select data format. GTS format: The conventional data SSS format: Including PCODE data , 'From' and 'To' data for Point to Line.	[F1]	<pre> DATA TRANSFER F1:SEND DATA F2:LOAD DATA F3:COMM. PARAMETERS </pre>
5 Press the [F1] key.	[F1]	<pre> SEND DATA F1:MEAS. DATA F2:COORD. DATA F3:PCODE DATA </pre>
6 Select the type of data to send by pressing [F1]-[F3] key. Example : [F1](MEAS. DATA)	[F1]	<pre> SELECT A FILE FN: _____ INPUT LIST --- ENTER </pre>
7 Press the [F1](INPUT) key and enter File Name you want to send. Press the [F4](ENT) key. *1),2)	[F1] Enter FN [F4]	<pre> SEND MEAS. DATA >OK ? --- --- [YES] [NO] </pre>
8 Press the [F3](YES) key .*3) The sending starts. The display will return to menu.	[F3]	<pre> SEND MEAS. DATA < Sending Data!> STOP </pre>

*1) Refer to Section 2.5 "How to Enter Alphanumeric characters".
*2) To scroll the data, press the [▲] or [▼] key.
•To show the file list, press the [F2](LIST) key.
*3) To cancel the sending, press the [F4](STOP) key.

9.7.2 Loading Data

Coordinate data files and PCODE Library data can be loaded from PC.
 Example: Loading a coordinate data file

Operating procedure	Operation	Display
1 Press the [F3](MEMORY MGR.) key from the menu 1/3.	[F3]	<pre> MEMORY MGR. 1/3 F1:FILE STATUS F2:SEARCH F3:FILE MAINTAN P↓ </pre>
2 Press the [F4](P↓) key twice.	[F4] [F4]	<pre> MEMORY MGR. 3/3 F1:DATA TRANSFER F2:INITIALIZE P↓ </pre>
3 Press the [F1](DATA TRANSFER) key .	[F1]	<pre> DATA TRANSFER F1:GTS FORMAT F2:SSS FORMAT </pre>
4 Press the [F1](GTS FORMAT) key .	[F1]	<pre> DATA TRANSFER F1:SEND DATA F2:LOAD DATA F3:COMM. PARAMETERS </pre>
5 Press the [F2] key.	[F2]	<pre> LOAD DATA F1:COORD. DATA F2:PCODE DATA </pre>
6 Select the type of data to load by pressing [F1] or [F2] key. Example : [F1](COORD. DATA)	[F1]	<pre> COORD. FILE NAME FN: _____ INPUT --- --- ENTER </pre>
7 Press the [F1](INPUT) key and enter New File Name you want to receive. Press the [F4](ENT) key. *1)	[F1] Enter FN [F4]	<pre> LOAD COORD. DATA >OK ? --- --- [YES] [NO] </pre>
8 Press the [F3](YES) key.*2) The loading starts. The display will return to menu.	[F3]	<pre> LOAD COORD. DATA < Loading Data!> STOP </pre>
<p>*1) Refer to Section 2.5 "How to Enter Alphanumeric characters". *2) To cancel the loading, press the [F4](STOP) key.</p>		

9.7.3 Setting Parameter of Data Communications

•Items of the Parameter

Item	Selecting Item	Contents
F1: Protocol	[ACK/NAK], [ONE WAY]	Setting Protocol [ACK/NAK] or [ONE WAY] communication
F2: Baud rate	1200, 2400, 4800, 9600, 19200,38400	Setting transfer speed 1200/2400/4800/9600 /19200/ 38400 baud rate
F3: Char. / Parity	[7/EVEN], [7/ODD], [8/NON]	Setting data length and parity. [7bit, even], [7bit, odd], [8bit,none]
F1: Stop Bits	1, 2	Setting Stop 1 bit or 2bits

1 **Example Setting** Baud rate : 19200

Operating procedure	Operation	Display
1 Press the [F3](MEMORY MGR.) key from the menu 1/3.	[F3]	<pre> MEMORY MGR. 1/3 F1:FILE STATUS F2:SEARCH F3:FILE MAINTAN P↓ </pre>
2 Press the [F4](P↓) key twice.	[F4] [F4]	<pre> MEMORY MGR. 3/3 F1:DATA TRANSFER F2:INITIALIZE P↓ </pre>
3 Press the [F1](DATA TRANSFER) key .	[F1]	<pre> DATA TRANSFER F1:GTS FORMAT F2:SSS FORMAT </pre>
4 Press the [F1](GTS FORMAT) key .	[F1]	<pre> DATA TRANSFER F1:SEND DATA F2:LOAD DATA F3:COMM. PARAMETERS </pre>
5 Press the [F3](COMM. PARAMETERS) key.	[F3]	<pre> COMM. PARAMETERS 1/2 F1:PROTOCOL F2:BAUD RATE F3:CHAR./PARITY P↓ </pre>
6 Press the [F2](BAUD RATE) key. [] indicates present setting.	[F2]	<pre> BAUD RATE [1200] 2400 4800 9600 19200 38400 ENTER </pre>
7 Select the items by pressing [▲]or[▼] , [◀] and [▶] keys. *1)	[▶] [▼]	<pre> BAUD RATE 1200 2400 4800 9600 [19200]38400 ENTER </pre>
8 Press the [F4](ENTER) key.	[F4]	<pre> COMM. PARAMETERS 1/2 F1:PROTOCOL F2:BAUD RATE F3:CHAR./PARITY P↓ </pre>

*1) To cancel setting, press the [ESC] key.

9.8 Initialization

This mode is used to initialize the internal memory.

Following data can be initialized.

FILE DATA :All files of measuring data and coordinate data

PCODE DATA: PCODE LIST

ALL DATA: FILE DATA and PCODE DATA

Note that the following data are not initialized even if initialization is executed.

: Coordinates of the instrument, Instrument height and Reflector height.

Example Initialization: ALL DATA (FILE data and PCODE data)

Operating procedure	Operation	Display
1 Press the [F3](MEMORY MGR.) key from the menu 1/3.	[F3]	<pre> MEMORY MGR. 1/3 F1:FILE STATUS F2:SEARCH F3:FILE MAINTAN. P↓ </pre>
2 Press the [F4](P↓) key twice.	[F4] [F4]	<pre> MEMORY MGR. 3/3 F1:DATA TRANSFER F2:INITIALIZE P↓ </pre>
3 Press the [F2](INITIALIZE) key.	[F2]	<pre> INITIALIZE F1:FILE AREA F2:PCODE LIST F3:ALL DATA </pre>
4 Select the data to initialize by pressing one of the [F1] to [F3] key. Example : [F3](ALL DATA)	[F3]	<pre> INITIALIZE DATA ERASE ALL DATA ! >OK ? [NO] [YES] </pre>
5 Confirm the erase data, press the [F4](YES) key. Initializing will start. The display returns to menu.	[F4]	<pre> INITIALIZE DATA <Initializing!> ↓ MEMORY MGR. 3/3 F1:DATA TRANSFER F2:INITIALIZE P↓ </pre>

10 SET AUDIO MODE

The light acceptance quantity level for the EDM (SIGNAL), the atmospheric correction value (PPM) and correction value of prism constant (PSM) are displayed in this mode.

When reflected light from the prism is received a buzzer sounds. This function is good for easy collimation when the target is difficult to find.

Operating procedure	Operation	Display
<p>1 Make sure the mode is in the distance measurement mode on page 1.</p>		<pre>HR: 120°30'40" HD* 123.456 m VD: 5.678 m MEAS MODE S/A P1↓</pre>
<p>2 Pressing the [F3](S/A) key, mode changes to set audio mode.</p> <p>The display indicates correction value of prism constant (PSM), atmospheric correction (PPM) and reflection light level (SIGNAL).</p>	[F3]	<pre>SET AUDIO MODE PSM:0.0 PPM 0.0 SIGNAL: [y y y y] PRISM PPM T-P ---</pre>
<ul style="list-style-type: none"> •When receiving reflected light, buzzer sounds. It is possible to stop the sound, see Chapter 16 "SELECTING MODE" . •The [F1] to [F3] keys are used for setting atmospheric correction and prism constant. •To return to normal measuring mode, press the [ESC] key. 		

11 SETTING THE PRISM CONSTANT VALUE

The prism constant value of geo-FENNEL is set to zero. When using prisms other than geo-FENNEL, it is necessary to set the prism constant correction value of that specific prism. Once you set the correction value for prism constant, it is retained after power is OFF.

Operating procedure	Operation	Display
1 Press the [F3](S/A) key from distance measurement or coordinates measurement mode.	[F3]	<pre> SET AUDIO MODE PSM:0.0 PPM 0.0 SIGNAL: [y y y y] PRISM PPM T-P --- </pre>
2 Press the [F1](PRISM) key.	[F1]	<pre> PRISM CONST. SET PRISM =0.0 mm --- --- [CLR] [ENT] </pre>
3 Input the Prism constant correction value. *1) The display returns to set audio mode.	Enter data [F4]	<pre> SET AUDIO MODE PSM:14.0 PPM 0.0 SIGNAL: [y y y y] PRISM PPM T-P --- </pre>
*1) Refer to Section 2.5 "How to Enter Alphanumeric characters". •Input range : -99.9mm to +99.9mm,0.1mm step		

12 SETTING ATMOSPHERIC CORRECTION

The velocity of light through air is not constant and depends on the atmospheric temperature and pressure. The atmospheric correction system of this instrument corrects automatically when the correction value is set. 15°C/59°F, and 1013.25hPa / 760mmHg / 29.9 inHg is as a standard value for 0ppm in this instrument. The values are kept in the memory even after power is OFF.

12.1 Calculation of Atmospheric Correction

The followings are the correction formulas.

Unit; meter

$$Ka = \left\{ 279.67 - \frac{79.535 \times P}{273.15 + t} \right\} \times 10^{-6}$$

Ka: Atmospheric correction value
P : Ambient atmospheric pressure (hPa)
t : Ambient Atmospheric temperature (°C)

The distance L (m) after atmospheric correction is obtained as follow.

$$L = l (1 + Ka)$$

l : Measured distance when atmospheric correction is not set.

Example : In case Temperature +20°C, Air pressure 847hPa, l = 1000 m

$$Ka = \left\{ 279.67 - \frac{79.535 \times 847}{273.15 + 20} \right\} \times 10^{-6}$$

$$\cong + 50 \times 10^{-6} \text{ (50 ppm)}$$

$$L = 1000 (1 + 50 \times 10^{-6}) = 1000.050 \text{ m}$$

12.2 Setting of Atmospheric Correction Value

•How to Set Temperature and Pressure Value Directly

Measure the temperature and air pressure surrounding the instrument beforehand.

Example : Temperature: +26°C, Pressure: 1017 hPa

Operating procedure	Operation	Display
1 Press the [F3](S/A) key to set Set Audio Mode from distance or coordinate measurement mode.	[F3]	<div style="border: 1px solid black; padding: 5px;"> SET AUDIO MODE PSM: 0.0 PPM 0.0 SIGNAL: [y y y y] PRISM PPM T-P --- </div>
2 Press the [F3](T-P) key.	[F3]	<div style="border: 1px solid black; padding: 5px;"> TEMP. & PRES. SET TEMP. = 15.0 °C PRES. : 1013.2 hPa --- --- [CLR] [ENT] </div>
3 Input Temp.value and Pressure value.*1) Mode returns to Set Audio mode.	Enter Temp. Enter Pres.	<div style="border: 1px solid black; padding: 5px;"> TEMP. & PRES. SET TEMP. : 26.0 °C PRES. = 1017.0 hPa --- --- [CLR] [ENT] </div>
*1) Refer to Section 2.5 "How to Enter Alphanumeric characters". •Range : Temp. -30 to +60°C (0.1°C step) or -22 to +140°F (0.1°F step) Pres. 560 to 1066.0hPa (0.1hPa step) ,420 to 800mmHg (0.1mmHg step) or 16.5 to 31.5inHg (0.1inHg step) • When the atmospheric correction value which is calculated from the input temperature and pressure values exceeds the range ± 999.9ppm, the operating procedure returns to step 3 automatically. Input values again.		

•How to Set the Atmospheric Correction Value Directly

Measure the temperature and air pressure to find atmospheric correction value (PPM) from the chart or correction formula.

Operating procedure	Operation	Display
<p>1 Press the [F3](S/A) key to set Set Audio Mode from distance or coordinate measurement mode.</p>	<p>[F3]</p>	<pre> SET AUDIO MODE PSM:0.0 PPM 0.0 SIGNAL: [y y y y] PRISM PPM T-P --- </pre>
<p>2 Press the [F2](PPM) key. Current setting value is displayed.</p>	<p>[F2]</p>	<pre> PPM SET PPM = 0.0 ppm --- --- [CLR] [ENT] </pre>
<p>3 Enter atmospheric correction value. *1) Mode returns to Set Audio mode.</p>	<p>Enter Data [F4]</p>	
<p>*1) Refer to Section 2.5 "How to Enter Alphanumeric characters". •Input range : -999.9ppm to +999.9ppm,0.1ppm step</p>		

Atmospheric Correction Chart (For your reference)

The atmospheric correction value is obtained easily with the atmospheric correction chart. Find the measured temperature in horizontal, and pressure in vertical on the chart. Read the value from the diagonal line, which represents the required atmospheric correction value.

Example:

The measured temperature is +26°C

The measured pressure is 1013 hPa

There fore,

The correction value is +10ppm

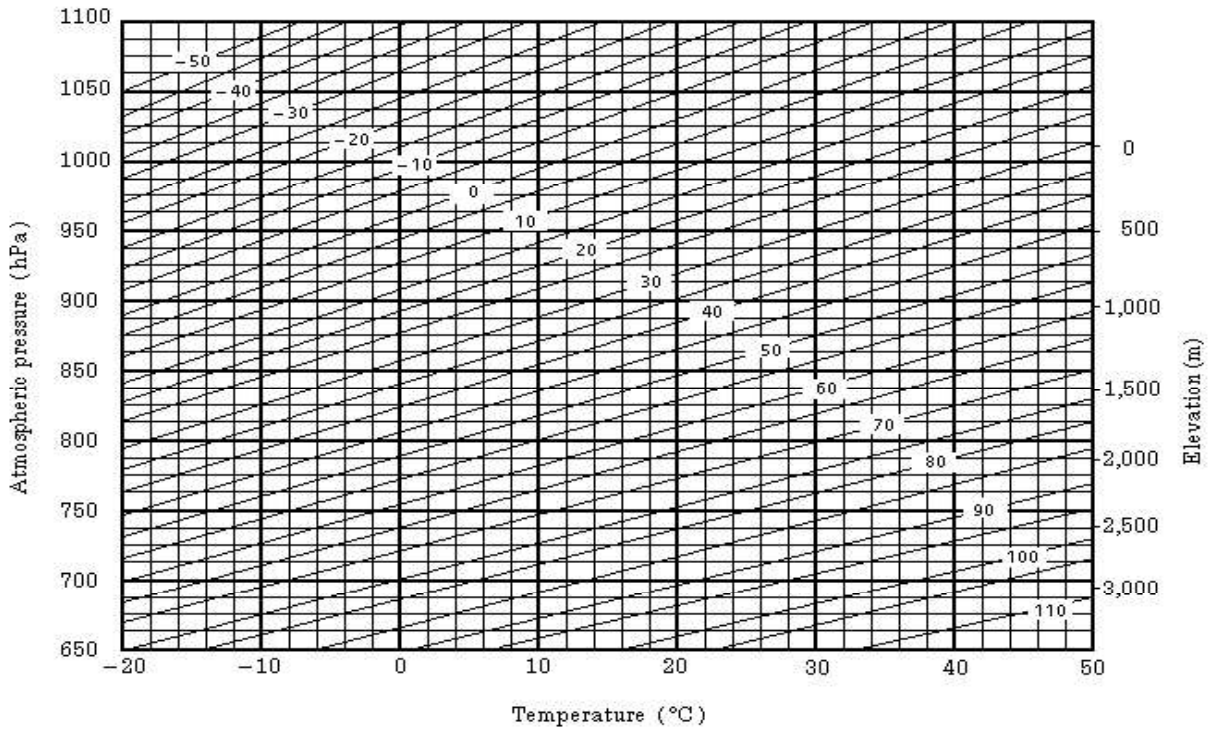

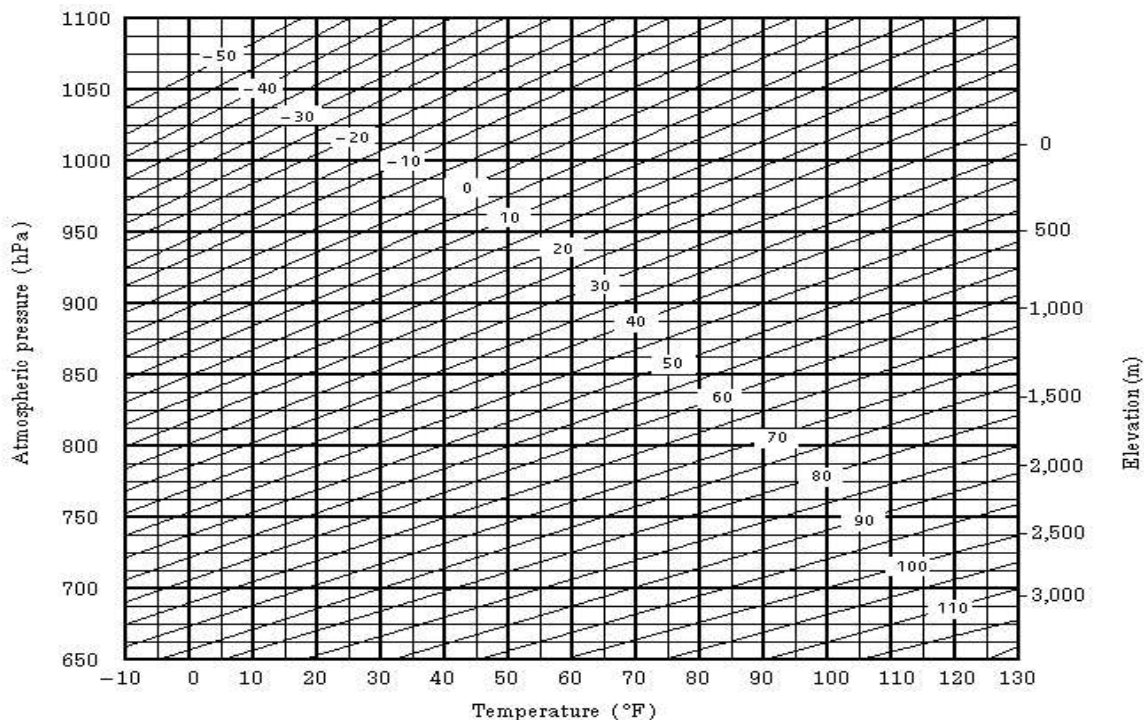
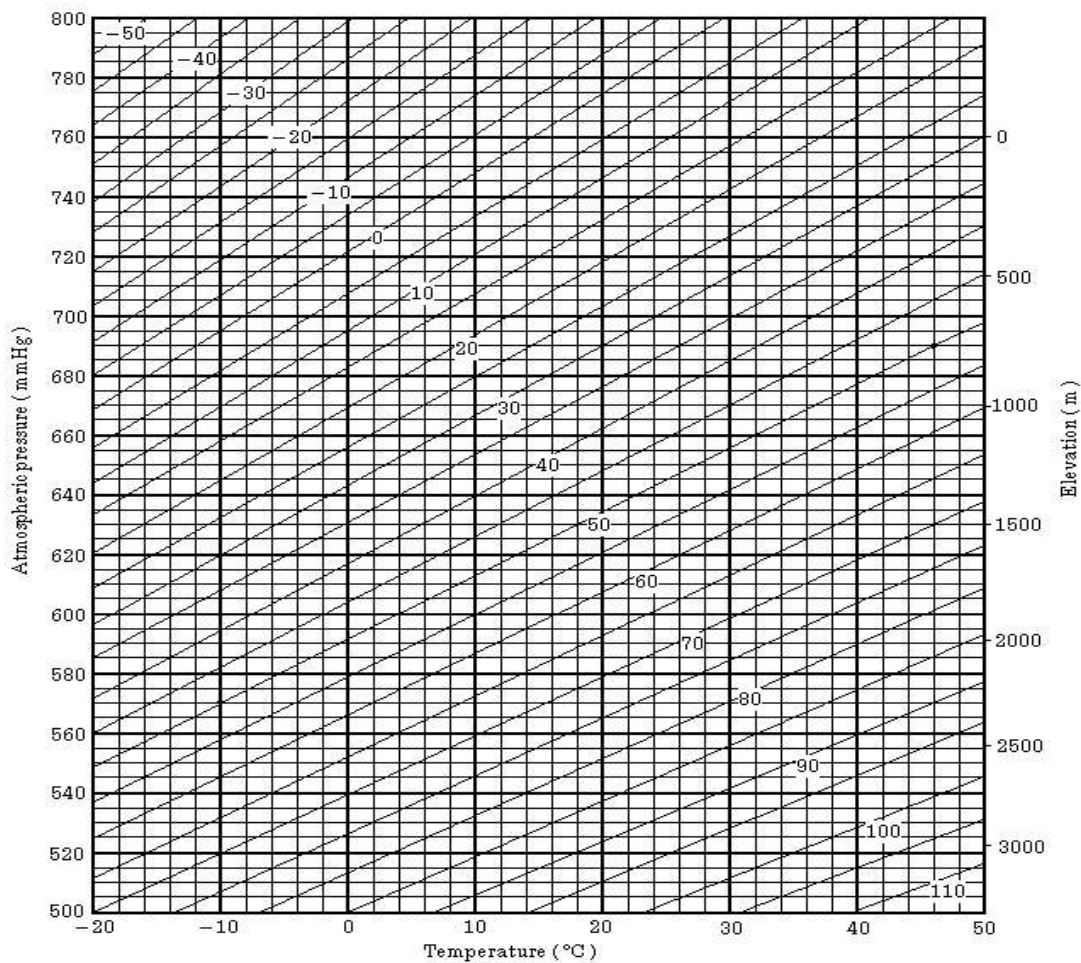

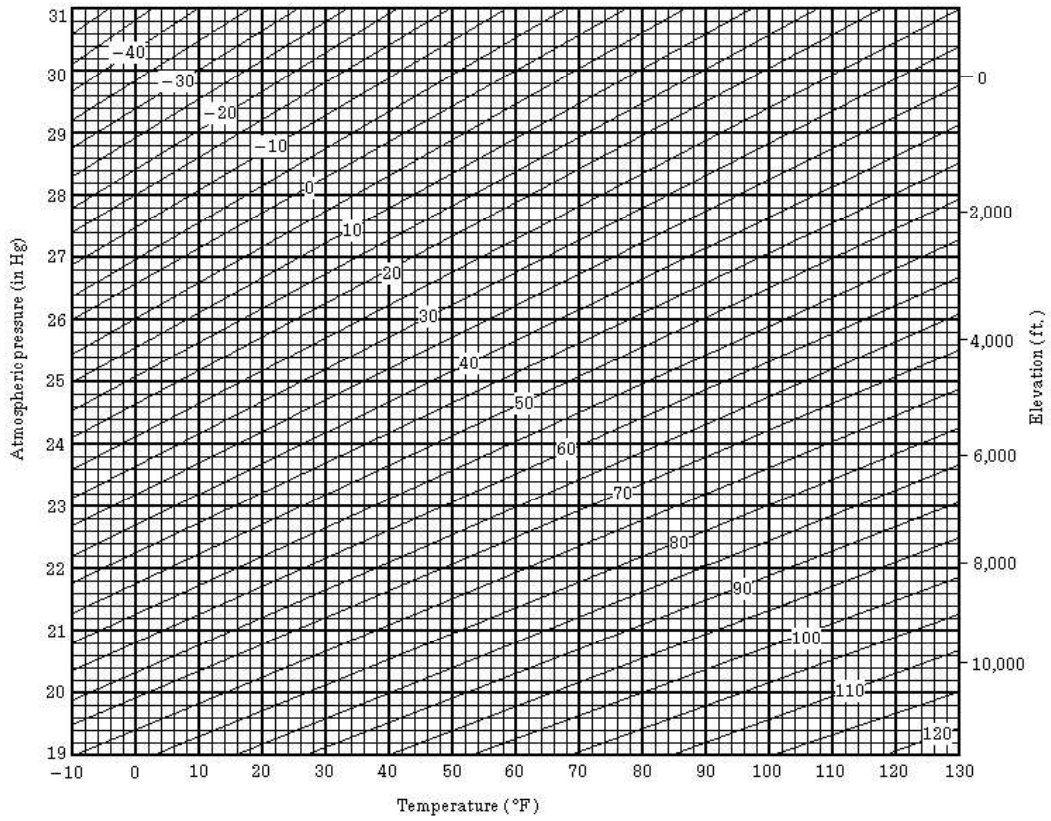

13 CORRECTION FOR REFRACTION AND EARTH CURVATURE

The instrument measures distance, taking into account correction for refraction and earth curvature.

13.1 Distance Calculation Formula

Distance Calculation Formula; with correction for refraction and earth curvature taken into account. Follow the Formula below for converting horizontal and vertical distances.

- Horizontal distance $D = AC(\alpha)$ or $BE(\beta)$
- Vertical distance $Z = BC(\alpha)$ or $EA(\beta)$
- $D = L\{\cos\alpha - (2\theta - \gamma) \sin\alpha\}$
- $Z = L\{\sin\alpha + (\theta - \gamma) \cos\alpha\}$
- $\theta = L \cdot \cos\alpha / 2R$ Earth curvature correcting item
- $\gamma = K \cdot L \cos\alpha / 2R$ Atmospheric refraction correcting item
- $K = 0.14$ or 0.2 Coefficient of refraction
- $R = 6372\text{km}$ Radius of earth
- α (or β)..... Altitude angle
- L Slope distance

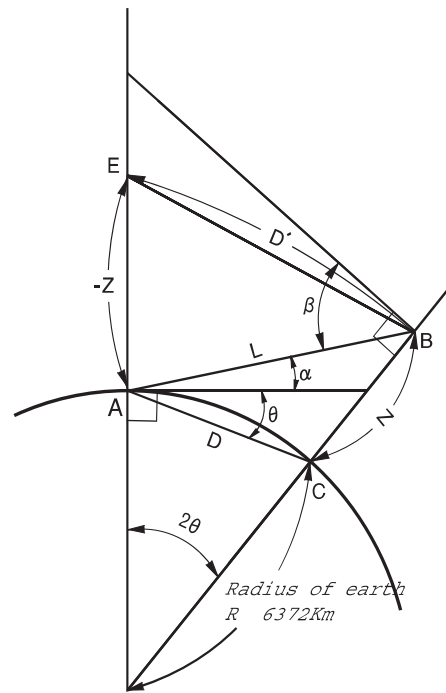

- The conversion formula for horizontal and vertical distances is as follows when correction for refraction and earth curvature is not applied.
 $D = L \cdot \cos\alpha$
 $Z = L \cdot \sin\alpha$

Note: The coefficient of the instrument has been set at 0.14 before shipment (K=0.14). if the "K" value is to be changed, refer to 16 "SELECTING MODE".

14 POWER SOURCE AND CHARGING

14.1 On-board Battery BT-G1

•To remove

- 1 Confirm that the instrument is turned off before removing the battery.
Push the battery locking lever and pull out the BT-G1 on-board battery as shown below.

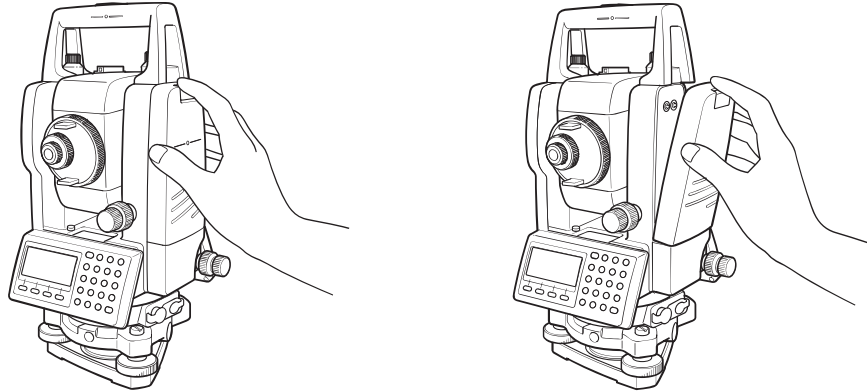

•To charge

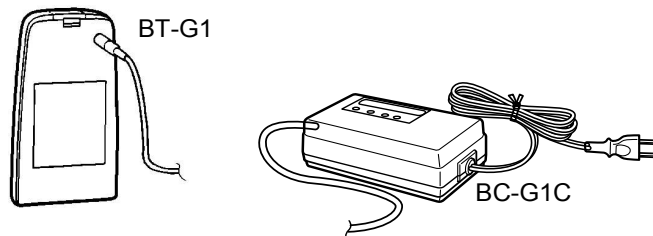

- 1 Plug the charger into the outlet. Use an AC cable compatible with the power supply voltage in use.
- 2 Connect the charger connector to the battery, then charging will start.
Preparatory charging will start. (The red lamp of the charger will blink.)
When the preparatory charging is completed, the charging status will be switched to quick charging automatically. (The red lamp of the charger will light.)
- 3 Charging will take approximately 1.8 hours. (The green lamp will illuminate.)
- 4 After charging, remove the battery from the charger.
- 5 Remove the charger from the outlet.

1 To refresh

Press the refresh switch after starting charging above steps (1, 2), then discharging will start. Confirm the yellow lamp illuminates.

After discharging is finished, charging will start automatically.

Time discharging battery charged fully is approximately 10 hours.

•For refreshing

Rechargeable battery can be used repeatedly by charging. If charging is repeated by the state that capacity of the battery still left, operating time of the battery may shorten. In this case, the voltage of the battery will be recovered by refreshing and operating time can be improved.

• About Preparatory charging

Before quick charging, the battery is charged using small amount current to measure its temperature and voltage.

When the temperature and voltage is within a range, the charging status will change to quick charging.

The lamp of charger

- Red blinking** : Preparatory charging /Waiting until internal temperature falls
- Red ON** : Charging
Red lamp will illuminate during charging.
- Green ON** : Charging completed
Green lamp will illuminate after completely charging.
- Yellow ON** : Discharging
Yellow lamp will illuminate and discharging will start by pressing the refresh (discharge) switch.

Red quick flashing : Abnormal outbreaks

Red lamp will flash when the battery life is over or the battery is broken down.
Replace the battery to new one.

•To install

- 1 Place the base of the on-board battery into the FTS 300 series, push the on-board battery toward the instrument side till the battery clicks into position.

- Do not charge or discharge continuously, otherwise the battery and the charger may be deteriorated. If charging or discharging is necessary, use the charger after stopping charge for approximately 30 minutes.
- Do not charge the battery or discharge the battery in right after the battery is charged, it causes deterioration of the battery in rare cases.
- The charger may develop heat while charging, there is no problem of it.

- Note:
- 1 Recharging should take place in a room with an ambient temperature range of 10°C to 40°C (50°F to 104°F).
 - 2 If charging is done at high temperature, charging time of the battery may take longer.
 - 3 Exceeding the specified charging time may shorten the life of the battery and should be avoided if possible.
 - 4 The battery source will discharge when stored and should be checked before using with instrument .
 - 5 Be sure to charge as stored battery source every 3 or 4 months and store in a place at 30°C and below when it will not used for a long period.
If you allow the battery to be completely discharged, it will have an effect on the overall performance for proper charging in the future.
Keep batteries charged at all times.
 - 6 For further information, see APPENDIX 2 “Precaution when Charging or Storing Batteries”.

15 DETACH/ATTACH OF TRIBRACH

The instrument is easily detached or attached to the tribrach, with a tribrach locking lever loosened or tightened for this purpose.

•Detachment

- 1) Loosen the tribrach locking lever, by revolving it 180° or 200g in the counterclockwise direction (which will point the triangle mark upwards).
- 2) Grip the carrying handle firmly with one hand while holding the tribrach with the other. Then lift the instrument straight upwards and off.

•Attachment

- 1) Hold the instrument by the carrying handle, with one hand, and carefully lower it on top of the tribrach while, at the same time, coinciding the alignment piece with the tribrach alignment groove on the instrument and tribrach respectively.
- 2) When fully seated, revolve the tribrach locking lever 180° or 200g clockwise (which will point the triangle mark downwards again).

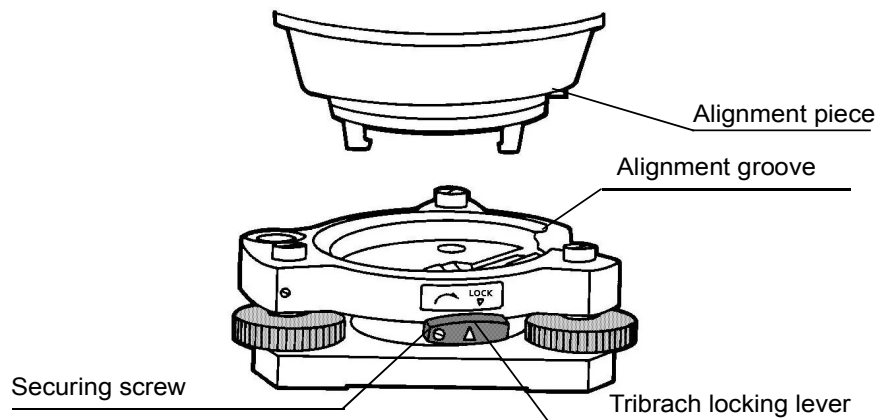

•Locking the Tribrach Locking Lever

The tribrach locking lever can be locked, to prevent it be accidentally removed, especially if the upper instrument section is not being detached very often. Simply tighten the securing screw on the locking lever with the accessory screwdriver, found in the case.

16 SELECTING MODE

16.1 Items of the Selecting Mode

The following modes are available.

Menu	Items	Selecting item	Display
1: UNIT SET	TEMP. & PRES.	°C / °F hPa / mmHg / inHg	Select the unit of temperature for atmospheric correction. Select the unit of air pressure for atmospheric correction .
	ANGLE	DEG(360°) / GON(400G) / MIL(6400M)	Choose degree, gon or mil unit for measuring angle.
	DISTANCE	METER / FEET / FEET and inch	Choose measuring unit for distance meter , feet or feet and inch
	FEET	US SURVEY / INTERNATIONAL	Select the meter / feet conversion factor. US SURVEY feet 1m=3.280833333333333 ft. INTERNATIONAL feet 1m=3.280839895013123 ft.
2: MODE SET	POWER ON MODE	ANGLE MEAS./ DISTANCE MEAS.	Select to set the measurement mode for angle or distance when the power is turned on.
	FINE/CRS/ TRK	FINE / COARSE / TRACK	Select Fine /Coarse / Tracking mode in distance measurement mode, when the power is turned on.
	HD&VD/SD	HD&VD /SD	Specify which is displayed first, horizontal and vertical distance or slope distance, when the power is turned on.
	V ANGLE Z0/H0	Zenith 0 / Horizontal 0	Choose the vertical angle reading from zenith or from level.
	N-TIMES / REPEAT	N-TIMES / REPEAT	Select the measurement mode for distance when the power is turned on.
	TIMES OF MEAS.	0~99	Set N (number of times) for times of distance measurement. When setting number of times as 1, it is single measurement.
	NEZ / ENZ	NEZ / ENZ	Select a coordinate displaying order either NEZ or ENZ.
	HA MEMORY	ON / OFF	Horizontal angle set can be retained after the power is turned off.
	ESC KEY MODE	DATA COLLECT / LAYOUT / REC / OFF	You can select a function of the [ESC] key. DATA COLLECT / LAYOUT: It is possible to enter data input mode (in DATA COLLECT) or Layout Menu from normal measuring mode directly. REC: While executing normal or offset measuring, the measuring data can be output. OFF: Returns to normal function.
COORD. CHECK	ON / OFF	Select coordinate displaying ON or OFF when setting a point.	

	EDM OFF TIME	0-99	The time when EDM is cut off from distance measurement is completed can be changed. This function is effective for shortening the first time measuring time when distance measurement is started from distance measurement completing state. (Default:3minutes) 0 :After completing distance measurement, EDM is cut off immediately. 1-98 :EDM is cut off after 1~98 minutes. 99 :EDM is always switched ON.
	FINE READING	0.2/1mm	Select 1mm or 0.2mm for the minimum reading unit in the distance mode (FINE mode).
	OFFSET V ANG	FREE / HOLD	Select Vertical angle setting in the Angle Offset measurement mode. FREE: Vertical angle varies by the angle of the telescope. HOLD: Vertical angle is fixed even if the angle of the telescope changes.
3: OTHERS SET	H-ANGLE BUZZER	ON / OFF	Specify whether the buzzer sounds or not for every horizontal angle 90°.
	S/A BUZZER	ON / OFF	Specify whether the buzzer sounds or not in the set audio mode.
	W-CORRECTION	OFF / K=0.14 / K=0.20	Set correction for refraction and earth curvature, coefficient of refraction as ; K=0.14, K=0.20 or no correction.
	NEZ MEMORY	ON / OFF	It is possible to retain the coordinate of instrument point, the instrument height and prism height after power off.
	REC TYPE	REC-A / REC-B	Select REC-A or REC-B for data output. REC-A :The measurement is made again and this new data is output. REC-B : The data being displayed is output.
	CR,LF	ON / OFF	It is possible to output the data with carriage return and line feed.
	NEZ REC FORM	STANDARD / STANDARD (12dig) / with RAW / with RAW (12dig)	Select the format of the record coordinates data STANDARD: 11 digits standard data STANDARD (12dig):12 digits standard data with RAW:11digits standard data with raw data with RAW (12dig):12digits standard data with raw data
	MANUAL NEZ REC	ON/ OFF	In the layout mode or data collect mode, it is possible to record coordinates entered directly from the keyboard.
	LANGUAGE *	ENGLISH/ OTHER *	Select the displaying language.
	ACK MODE	STANDARD / OMITTED	Set the procedure of the communication with external device. STANDARD:Normal procedure OMITTED:Even though the [ACK] is omitted from the external device, the data is not sent again.
	GRID FACTOR	USE G.F. / DON'T USE	Select using GRID FACTOR in calculation of measurement data.

CUT & FILL	STANDARD / CUT&FILL	In the layout mode, CUT & FILL can be displayed instead of dZ.
ECHO BACK	ON / OFF	It is possible to output the data of echo back type.
CONTRAST MENU	ON / OFF	When the instrument is turned ON, it is possible to display the screen which you can adjust contrast of the display and confirm the prism constant (PSM) and atmospheric correction value (PPM).

*LANGUAGE selection is different in each country.

16.2 How to Set Selecting Mode

<Example> : Setting unit in hPa, °F, NEZ MEMORY:ON

Operating procedure	Operation	Display
1 While pressing [F2] key, turn power ON.	[F2] + Power ON	PARAMETERS 2 F1:UNIT SET F2:MODE SET F3:OTHERS SET
2 Press [F1](UNIT SET) key.	[F1]	UNIT SET 1/2 F1:TEMP. & PRES. F2:ANGLE F3:DISTANCE P↓
3 Press [F1](TEMP. & PRES.) key.	[F1]	TEMP. & PRES. UNIT TEMP. : °C PRES. : mmHg °C °F --- ENTER
4 Press [F2](°F) key, and press [F4](ENTER) key.	[F2] [F4]	TEMP. & PRES. UNIT TEMP. : °F PRES. : mmHg hPa mmHg inHg ENTER
5 Press [F1](hPa) key, and press [F4] (ENTER) key. Returns to unit set menu.	[F1] [F4]	UNIT SET 1/2 F1:TEMP. & PRES. F2:ANGLE F3:DISTANCE
6 Press [ESC] key. Returns to PARAMETERS 2 menu.	[ESC]	PARAMETERS 2 F1:UNIT SET F2:MODE SET F3:OTHERS SET
7 Press [F3](OTHERS SET) key.	[F3]	OTHERS SET 1/5 F1:H-ANGLE BUZZER F2:S/A BUZZER F3:W-CORRECTION P↓
8 Press [F4](P↓) key, to get the function in page 2 .	[F4]	OTHERS SET 2/5 F1:NEZ MEMORY F2:REC TYPE F3:CR, LF P↓

<p>9 Press [F1] key.</p>	[F1]	<div style="border: 1px solid black; padding: 5px;"> <p>NEZ MEMORY [OFF]</p> <p>[ON] [OFF] --- ENTER</p> </div>
<p>10 Press [F1](ON) key, and press [F4] (ENTER) key. Returns to OTHERS SET menu.</p>	[F1] [F4]	<div style="border: 1px solid black; padding: 5px;"> <p>OTHERS SET 2/5</p> <p>F1:NEZ MEMORY</p> <p>F2:REC TYPE</p> <p>F3:CR,LF P↓</p> </div>
<p>11 Power off</p>	Power OFF	
<p>•Up or down arrow key can be used when there are four or more selection items.</p>		

17 CHECK AND ADJUSTMENT

17.1 Checking and adjusting of instrument constant

Normally, the instrument constant does not have discrepancy. It is recommended you measure and compare with an accurately measured distance at a location where the precision is specifically monitored on a consistent basis. If such a location is not available, establish your own base line over 20m (when purchasing the instrument) and compare the data measured with the newly purchased instrument.

In both cases note that the setup displacement of the instrument position over the point, the prism, baseline precision, poor collimation, atmospheric correction, and correction for refraction and earth curvature determine the inspection precision. Please keep in mind these points.

Also, when providing a base line in a building, please note that differences in temperature greatly affect the length measured.

If a difference of 5mm or over is the result from the comparative measurement, the following procedure as shown below could be used to change the instrument constant.

- 1) Provide point C on a straight line, connecting straight line AB which is almost level and about 100m long. Measure straight lines AB, AC and BC.

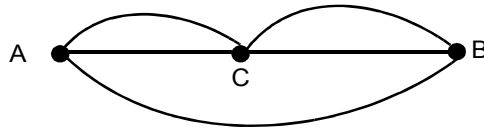

- 2) Obtain the instrument constant by repeating 1) above several times.
Instrument constant = $AC + BC - AB$
- 3) When there is error between written instrument constant value and calculated value, review Section 17.4 "How to Set the Instrument Constant Value"
- 4) Once again, measure at a calibrated baseline and compare results.
- 5) If using above procedure and no difference is found from the instrument constant at the factory or a difference of over 5mm is found, contact **geo-FENNEL** or your **geo-FENNEL** dealer.

Note: The seal with which the value is written is stuck on the lower part of the instrument, or the battery removal side of the instrument.

17.2 Checking the Optical Axis

To check if the optical axis of EDM and theodolite are matched, follow the procedure below. It is especially important to check after adjustment of the eyepiece reticle is carried out.

- 1) Position the Instrument and prism with about 2m apart and face them at each other.
(At this time, the power is ON.)

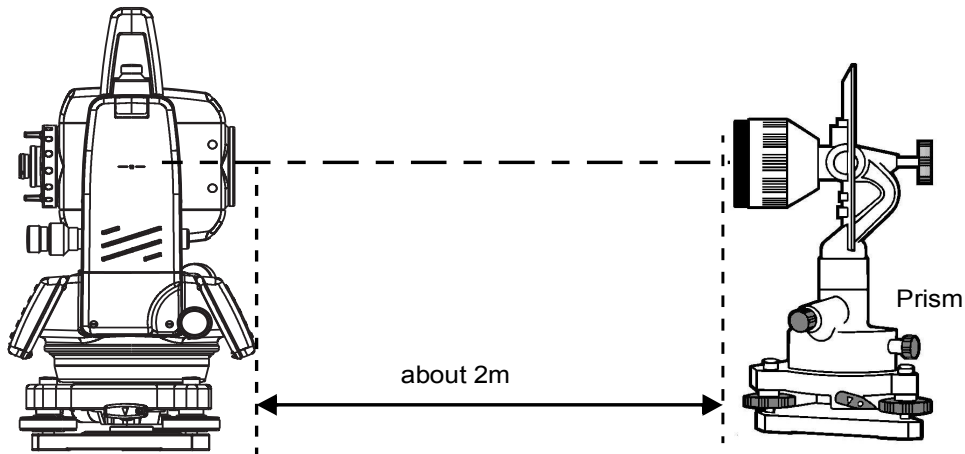

- 2) Sight through the eyepiece and focus to the prism. Then center the prism on the cross hairs.

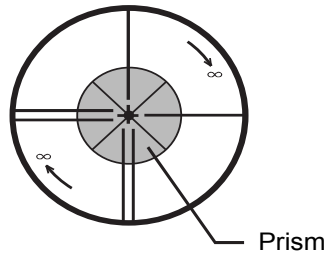

- 3) Set to the measure mode to distance measurement or set audio.
- 4) Sight through the eyepiece and focus the (blinking) red light spot by turning the focusing knob in the direction of infinity (clockwise). If displacement of the reticle cross hairs is within one-fifth of the diameter of the round red light spot both vertically and horizontally, adjustment will not be required.

Note: If displacement is more than one-fifth in the above case, and still remains so after rechecking the original line of sight, the instrument must be adjusted by competent technicians. Please contact **geo-FENNEL** or your **geo-FENNEL** dealer to adjust the instrument.

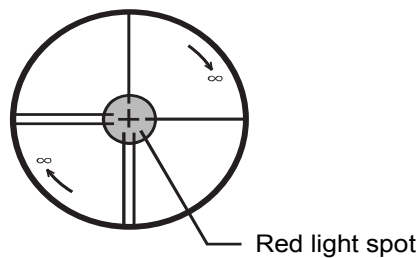

17.3 Checking/Adjusting the Theodolite Functions

•Pointers on the Adjustment

- 1) Adjust the eyepiece of the telescope properly prior to any checking operation which involves sighting through the telescope.
Remember to focus properly, with parallax completely eliminated.
- 2) Carry out the adjustments in the order of item numbers, as the adjustments are dependent one upon another. Adjustments carried out in the wrong sequence may even nullify previous adjustment.
- 3) Always conclude adjustments by tightening the adjustment screws securely (but do not tighten them more than necessary, as you may strip the threads, twist off the screw or place undue stress on the parts).
Furthermore, always tighten by revolving in the direction of tightening tension.
- 4) The attachment screws must also be tightened sufficiently, upon completion of adjustments.
- 5) Always repeat checking operations after adjustments are made, in order to confirm results.

•Notes on the Tribrach

Note that the angle measuring precision may be effected directly if the tribrach has not been installed firmly.

- 1) If any leveling screw becomes loose and slack or if collimation is unstable due to the looseness of leveling screws, adjust by tightening the adjusting screws (in 2 places) installed over each leveling screw with a screwdriver
- 2) If there is any slack between the leveling screws and the base, loosen the set screw of the holding ring and tighten the holding ring with adjusting pin, until it is properly adjusted. Re-tighten the set screw on completing the adjustment.

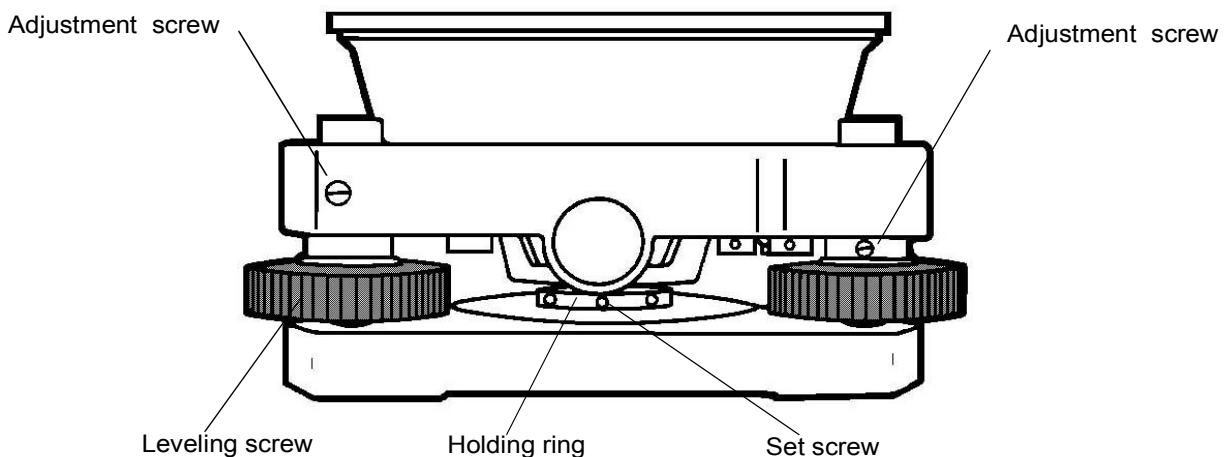

17.3.1 Checking /Adjusting the Plate Level

Adjustment is required if the axis of the plate level is not perpendicular to the vertical axis.

•Check

- 1) Place the plate level parallel to a line running through the centers of two leveling screws, say, A and B. Use these two leveling screws only and place the bubble in the center of the plate level.
- 2) Rotate the instrument 180° or 200g around the vertical axis and check bubble movement of the plate level. If the bubble has been displaced, then proceed with the following adjustment.

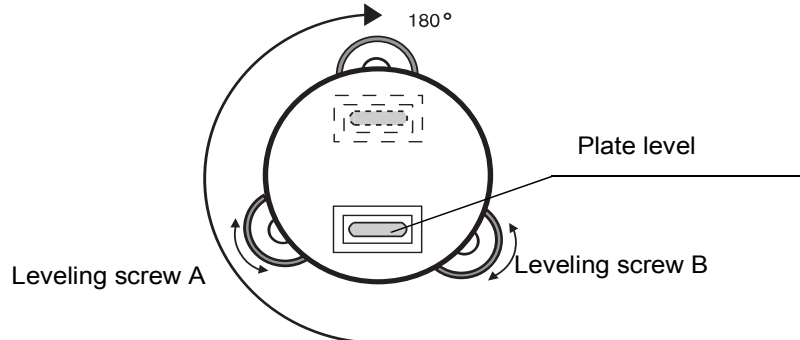

•Adjustment

- 1) Adjust the level adjustment capstan screw, with the accessory adjusting pin and return the bubble towards the center of the plate level. Correct only one-half of the displacement by this method.
- 2) Correct the remaining amount of the bubble displacement with the leveling screws.
- 3) Rotate the instrument 180° or 200g around the vertical axis once more and check bubble movement. If the bubble is still displaced, then repeat the adjustment.

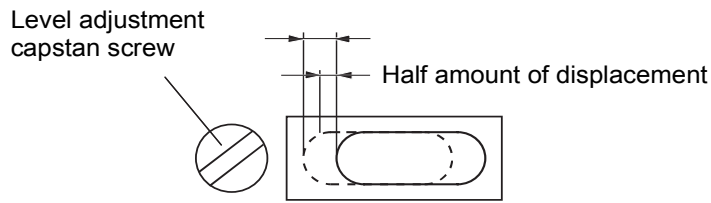

17.3.2 Checking /Adjusting the Circular Level

Adjustment is required if the axis of the circular level is also not perpendicular to the vertical axis.

•Check

- 1) Carefully level the instrument with the plate level only. If the bubble of the circular level is centered properly, adjustment is not required. Otherwise, proceed with the following adjustment.

•Adjustment

- 1) Shift the bubble to the center of the circular level, by adjusting three capstan adjustment screws on the bottom surface of the circular level, with the accessory adjusting pin.

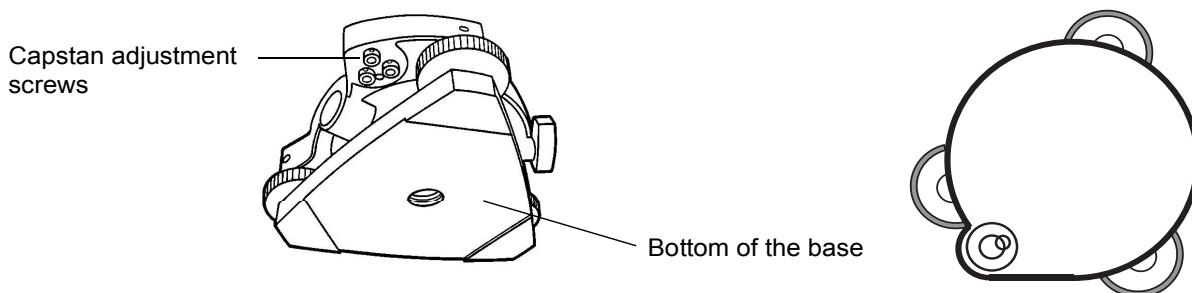

17.3.3 Adjustment of the Vertical Cross-hair

Adjustment is required if the vertical cross-hair is not in a plane perpendicular to the horizontal axis of the telescope (since it must be possible to use any point on the hair for measuring horizontal angles or running lines).

•Check

- 1) Set the instrument up the tripod and carefully level it.
- 2) Sight the cross-hairs on a well defined Point A at a distance of, at least, 50 meters (160ft.) and clamp horizontal motion.
- 3) Next swing the telescope vertically using the vertical tangent screw, and check whether the point travels along the length of the vertical cross-hair.
- 4) If the point appears to move continuously on the hair, the vertical cross-hair lies in a plane perpendicular to the horizontal axis (and adjustment is not required).
- 5) However, if the point appears to be displaced from the vertical cross-hair, as the telescope is swung vertically, then proceed with the following adjustment.

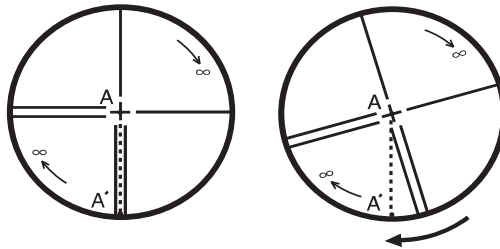

•Adjustment

- 1) Unscrew the cross-hair adjustment section cover, by revolving it in the counterclockwise direction, and take it off. This will expose four eyepiece section attachment screws.

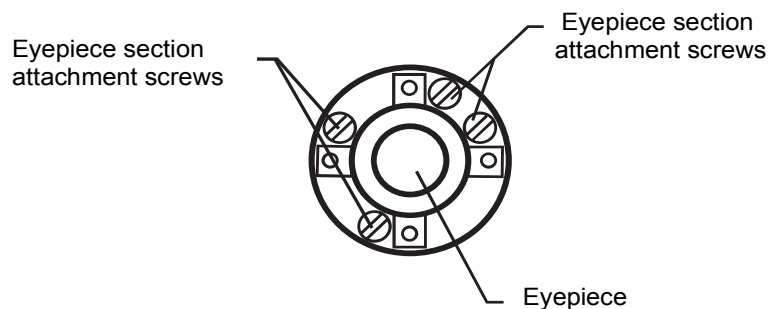

- 2) Loosen all four attachment screws slightly with the accessory screw-drive (while taking note of the number of revolutions). Then revolve the eyepiece section so that the vertical cross-hair coincides to Point A'. Finally, re-tighten the four screws by the amount that they were loosened.
- 3) Check once more and if the point travels the entire length of the vertical cross-hair, further adjustment is not required.

Note: Perform following adjustment after completing the above adjustment .
Section 17.3.4 "Collimation of the Instrument", Section 17.3.6 "Adjustment of Vertical Angle 0 Datum".

17.3.4 Collimation of the Instrument

Collimation is required to make the line of sight of the telescope perpendicular to the horizontal axis of the instrument, otherwise, it will not be possible to extend a straight line by direct means.

•Check

- 1) Set the instrument up with clear sights of about 50 to 60 meters (160 to 200 ft.) on both sides of the instrument.
- 2) Level the instrument properly with the plate level.
- 3) Sight Point A at approximately 50 meters (160 ft.) distance.
- 4) Loosen the vertical motion clamp only, and rotate the telescope 180° or 200g around the horizontal axis, so that the telescope is pointed in the opposite direction.
- 5) Sight Point B, at equal distance as Point A and tighten the vertical motion clamp.
- 6) Loosen the horizontal motion clamp and rotate the instrument 180° or 200g around the vertical axis. Fix a sight on Point A once more and tighten the horizontal motion clamp.
- 7) Loosen the vertical motion clamp only and rotate the telescope 180° or 200g around the horizontal axis once more and fix a sight on Point C, which should coincide with previous Point B.
- 8) If Points B and C do not coincide, adjust in the following manner.

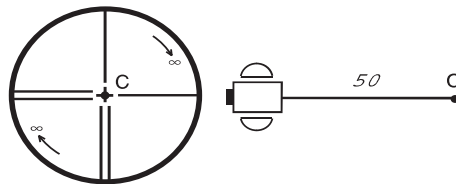
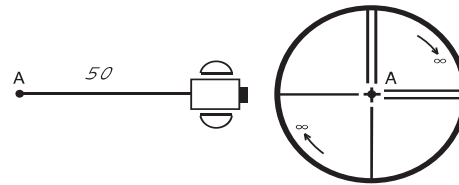
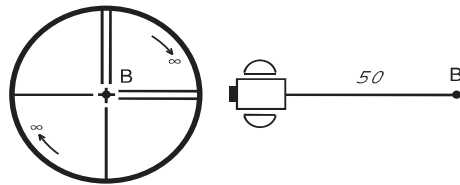
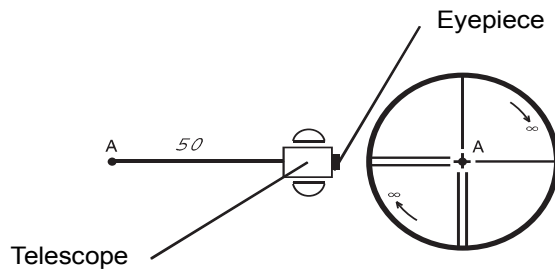

•Adjustment

- 1) Unscrew the cross-hair adjustment section cover.
- 2) Find Point D at a point between Points C and B, which should be equal to 1/4th the distance between Points B and C and measured from Point C. This is because the apparent error between Points B and C is four times the actual error since the telescope has been reversed twice during the checking operation.

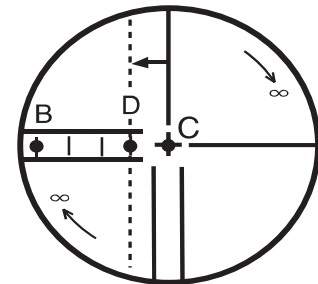

3) Shift the vertical cross-hair line and coincide it with Point D, by revolving the left and right capstan adjustment screws with the adjusting pin. Upon completing the adjustment, repeat the checking operation once more. If Points B and C coincide, further adjustment is not required. Otherwise, repeat the adjustment.

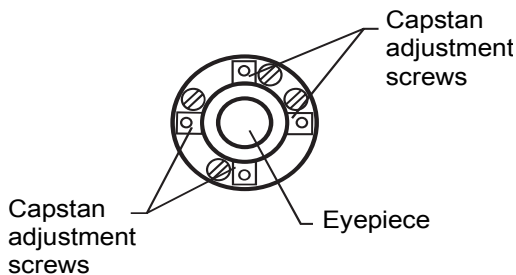

- Note: 1 First, loosen the capstan adjustment screw on the side to which the vertical cross-hair line must be moved. Then tighten the adjustment screw on the opposite side by an equal amount which will leave the tension of the adjustment screws unchanged. Revolve in the counterclockwise direction to loosen and in the clockwise direction to tighten, but revolve as little as possible.
- 2 Perform following adjustment after completing above adjustment . Section 17.3.6 "Adjustment of Vertical Angle 0 Datum", Section 17.2 "Checking the Optical Axis".

17.3.5 Checking / Adjusting the Optical Plummet Telescope

Adjustment is required to make the line of sight of the optical plummet telescope coincide with the vertical axis (otherwise the vertical axis will not be in the true vertical when the instrument is optically plumbed).

•Check

- 1) Coincide the center mark and the point. (See Chapter 2 "PREPARATION FOR MEASUREMENT".)
- 2) Rotate the instrument 180° or 200g around the vertical axis and check the center mark. If the point is properly centered in the center mark, adjustment is not required. Otherwise, adjust in the following manner.

•Adjustment

- 1) Take off the adjustment section cover of the optical plummet telescope eyepiece. This will expose four capstan adjustment screws which should be adjusted with the accessory adjusting pin to shift the center mark to the point. However, correct only one-half of the displacement in this manner.

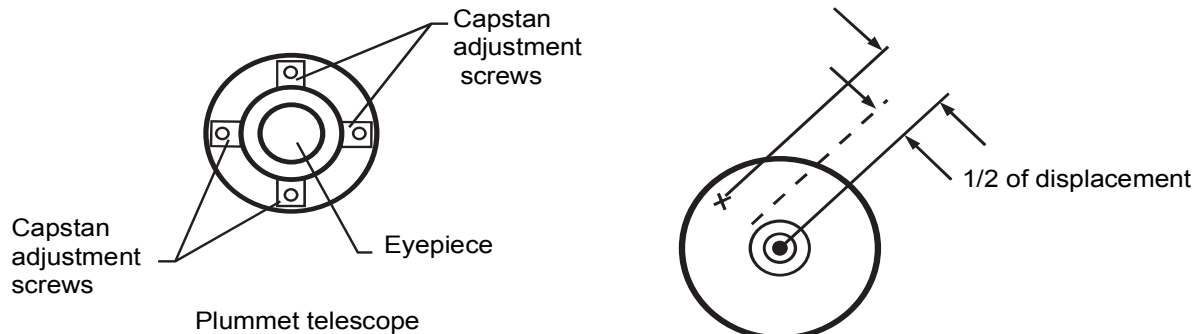

- 2) Use the leveling screws and coincide the point and center mark.
- 3) Rotate the instrument 180° or 200g around the vertical axis once more and check the center mark. If it is coincided to the point, then further adjustment is not required. Otherwise, repeat the adjustment.

- Note: First, loosen the capstan adjustment screw on the side to which the center mark must be moved. Then tighten the adjustment screw on the opposite side by an equal amount which will leave the tension of the adjustment screws unchanged. Revolve in the counterclockwise direction to loosen and in the clockwise direction to tighten, but revolve as little as possible.

17.3.6 Adjustment of Vertical Angle 0 Datum

If when measuring the vertical angle of target A at telescope position normal (direct) and reverse settings, the amount of normal and reverse measurements combined is other than 360° (ZENITH-0), half of the difference from 360° is the error amount from corrected 0 setting. Carry out adjustment. As adjustment for vertical angle 0 setting is the criteria for determining instrument coordinate origin, use special care for adjustment.

Operating procedure	Operation	Display
1 Level the instrument properly with the plate level.		
2 While pressing the [F1]key, turn power switch ON.	[F1] + Power ON	<div style="border: 1px solid black; padding: 5px;"> ADJUSTMENT MODE F1:V ANGLE 0 POINT F2:INST. CONSTANT F3:FRQ CHECK MODE </div>
3 Press the [F1] key.	[F1]	<div style="border: 1px solid black; padding: 5px;"> V0 ADJUSTMENT <STEP-1> FRONT V: 90°00'00" ENTER </div>
4 Collimate target A from the telescope properly in normal setting.	Collimate A (Normal)	
5 Press the [F4](ENTER) key.	[F4]	<div style="border: 1px solid black; padding: 5px;"> V0 ADJUSTMENT <STEP-2> REVERSE V: 270°00'00" ENTER </div>
6 Collimate target A in reverse telescope setting.	Collimate A (Reverse)	
7 Press the [F4](ENTER) key. Measured value is set and carry out normal angle measurement.	[F4]	<div style="border: 1px solid black; padding: 5px; text-align: center;"> <SET!> </div> <div style="text-align: center; margin: 5px 0;">↓</div> <div style="border: 1px solid black; padding: 5px;"> V : 270°00'00" HR: 120°30'40" OSET HOLD HSET P1↓ </div>
8 Check that the total amount of normal and reverse angular travel is 360° collimating the target A by normal and reverse positions.		

17.4 How to Set the Instrument Constant Value

To set the Instrument constant which is obtained in Section 17.1 "Check and adjusting of instrument constant", follow as below.

Operating procedure	Operation	Display
1 While pressing the [F1] key, turn power switch ON.	[F1] + POWER ON	<div style="border: 1px solid black; padding: 5px;"> ADJUSTMENT MODE F1:V ANGLE 0 POINT F2:INST. CONSTANT F3:FRQ CHECK MODE </div>
2 Press the [F2] key.	[F2]	<div style="border: 1px solid black; padding: 5px;"> INST. CONSTANT SET INST. CONSTANT = - 0.6 mm --- --- [CLR] [ENT] </div>
3 Enter the constant value. *1),2)	Enter value [F4]	<div style="border: 1px solid black; padding: 5px;"> INST. CONSTANT SET INST. CONSTANT : - 0.7 mm INPUT --- --- ENTER </div>
4 Turn power switch OFF.	Power OFF	
*1) Refer to Section 2.5 "How to Enter Alphanumeric characters". *2) To cancel the setting, press the [ESC] key.		

17.5 Reference frequency check mode

The beam modulated by the reference frequency of EDM is emitted continuously.
This mode is used for frequency test mainly.

Operating procedure	Operation	Display
1 While pressing the [F1] key, turn power switch ON.	[F1] + POWER ON	<div style="border: 1px solid black; padding: 5px;"> ADJUSTMENT MODE F1:V ANGLE 0 POINT F2:INST. CONSTANT F3:FRQ CHECK MODE </div>
2 Press the [F3](FRQ CHECK MODE) key.	[F3]	<div style="border: 1px solid black; padding: 5px;"> FRQ CHECK MODE EXIT </div>
3 Press the [F1](EXIT) key. The display will return to Adjustment mode menu 2/2.	[F1]	<div style="border: 1px solid black; padding: 5px;"> ADJUSTMENT MODE F1:V ANGLE 0 POINT F2:INST. CONSTANT F3:FRQ CHECK MODE </div>

18 PRISM SYSTEM

The following geo-FENNEL brand prism system is available.
Arrangement according to your needs is possible.

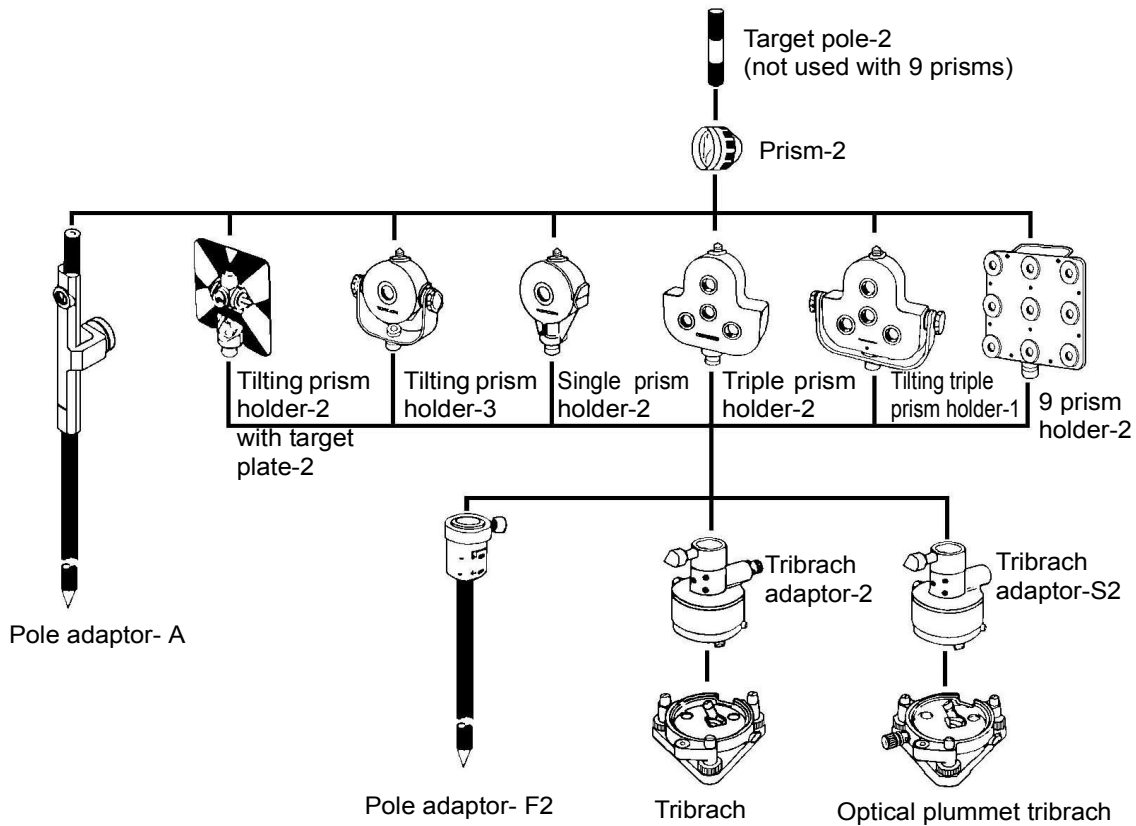

It is possible to change the combination according purpose.

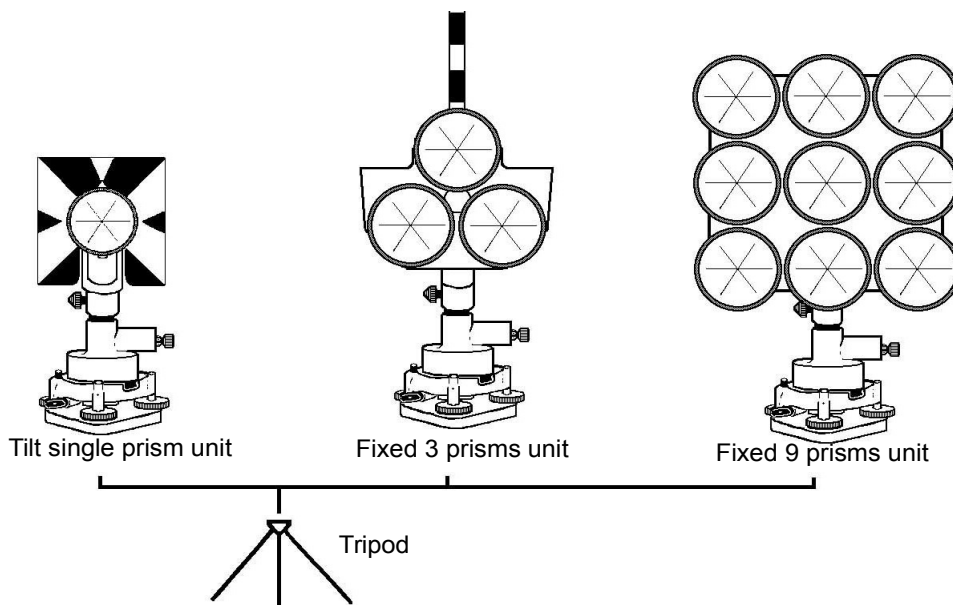

Use the above prisms after setting them at the same height as the instruments. To adjust the height of prism set, change the position of 4 fixing screws.

19 ERRORS DISPLAYS

Error code	Description	Countermeasures
3 points required	When area calculating, there are less than 3 points coordinate data in selected file.	Confirm the file data and calculate again.
CALC ERROR	Calculation is impossible from the data input.	Confirm the input data.
DELETE ERROR	When deleting coordinate data, it can not be done successful.	Confirm the data and delete again.
E35	Displayed when REM measurement carried out to the range from zenith or nadir $\pm 6^\circ$.	Operate in the range out of $\pm 6^\circ$ from the zenith or nadir.
E60's	Any abnormality occurs with EDM (distance measuring system).	Repair is required.
E71	Displayed when vertical angle 0 position is set with incorrect procedure.	Confirm the procedure and readjust.
E72	Displayed when Vertical angle -position is adjusted in wrong position.	Repair is required.
E73	The instrument was not leveled when Vertical angle 0-position is adjusted.	Level the instrument then carry the adjustment work.
E80's	Mainly at the time data transmission between FTS 300 series and external instrument.	Confirm operation procedure is correct or the connection cables are correct.
E90's	Abnormality in internal memory system.	Repair is required.
FILE EXISTS	The same file name exists.	Use another file name.
FULL FILES	When making a file, 30 files already exist.	If necessary, send or delete files.
FAILED INITIALIZE	Initializing can not be done successful.	Confirm initializing data and try to initialize again.
LIMIT OVER	Limit of input data exceeded.	Input again.
MEMORY ERROR	Any abnormality occurs with internal memory.	Initialize the internal memory.
MEMORY POOR	Shortage of capacity of the internal memory.	Download data from internal memory to PC.
NO DATA	The data is not found in the search mode	Confirm the data and search again.
NO FILE	There is no file in internal memory.	If necessary, make files.
FILE NOT SELECTED	When using a file, no file is selected.	Confirm the file and select a file.
P1-P2 distance too short	When in point to line measurement, the horizontal distance between first point and second point is within 1m.	The horizontal distance between first point and second point must be more than 1m.
CIRCULAR ERROR	Known points and occupied point are on the same circle at the resection mode.	Take the different point.

PT# EXIST	Same new point name is already memorized in the memory.	Confirm the new point name and input again.
PT# DOES NOT EXIST	When you enter incorrect name or PT# does not exist in the internal memory.	Enter the correct name or enter point in the internal memory.
RANGE ERROR	When setting a new point, calculation is impossible from the measured data.	Measure again.
Tilt Over	Instrument tilts over more than 3 minutes.	Level the instrument properly.
V ANGLE ERROR H ANGLE ERROR VH ANGLE ERROR	Abnormality in angle measuring system.	If this error code continues to display, repair is required.

- If error still persist after attempting to clear them, contact your local geo-FENNEL dealer or geo-FENNEL head office.

20 SPECIFICATIONS

Telescope

Length : 150mm
 Objective lens : 45mm (EDM 50mm)
 Magnification : 30×
 Image : Erect
 Field of view : 1°30'
 Resolving power : 3.0"
 Minimum focus : 1.3m
 Reticle illumination : Provided

Distance measurement

Measurement range

Prism	Atmospheric conditions	
	Condition 1	Condition 2
Mini prism	900m (3,000ft)	----
1 prism	2,000m (6,600ft)	2,300m (7,500ft)
3 prisms	2,700m (8,900ft)	3,100m (10,200ft)
9 prisms	3,400m (11,200ft)	4,000m (13,200ft)

Condition 1: Slight haze with visibility about 20km (12.5miles) moderate sunlight with light heat shimmer.

Condition 2: No haze with visibility about 40km(25 miles), overcast with no heat shimmer.

Measurement accuracy : ±(2mm +2ppm × D) m.s.e.
 D:Measuring distance (mm)

Least Count in Measurement

Fine measurement mode : 1mm (0.005ft.) / 0.2mm (0.001ft.)
 Coarse measurement mode : 10mm (0.02ft.) / 1mm (0.005ft.)
 Tracking measurement mode : 10mm (0.02ft.)

Measurement Display : 12 digits : max. display 99999999.9999

Measurement Time

Fine measurement mode : 1mm : 1.2sec. (Initial 4 sec.)
 0.2mm : 2.8sec. (Initial 5 sec.)
 Coarse measurement mode : 0.7sec. (Initial 3 sec.)
 Tracking measurement mode : 0.4sec. (Initial 3 sec.)
 (The initial time will be different by a condition and setting EDM off time.)

Atmospheric Correction Range : -999.9 ppm to +999.9 ppm , in 0.1 ppm increments

Prism Constant Correction Range : -99.9 mm to +99.9 mm , in 0.1 mm increments

Coefficient Factor : Meter / Feet

International feet 1meter = 3.28083989501 ft.

US SURVEY feet 1meter = 3.28083333333 ft.

Electronic Angle Measurement

Method	: Absolute reading
Detecting system:	
Horizontal angle	: 2 sides
Vertical angle	: 1 side
Minimum reading	: 5" / 1" (1mgon / 0.2mgon) reading
Accuracy(Standard deviation based on DIN 18723)	
FTS 300	: 2"(0.6mgon)
	: 5"(1.5mgon)
Measuring time	: Less than 0.3 sec.
Diameter of circle	: 71 mm

Tilt Correction (Automatic index)

Tilt sensor	: Automatic vertical compensator
Method	: Liquid type
Compensating Range	: $\pm 3'$
Correction unit	: 1" (0.1mgon)

Others

Instrument height	: 176mm (6.93in) Base unit detachable (Height from the tribrach dish to the center of telescope)
Level sensitivity	
Circular level	: 10'/2mm
Plate level	: 30"/2 mm
Optical Plummet Telescope	
Magnification	: 3×
Focusing range	: 0.5m to infinity
Image	: Erect
Field of view	: 5°(ϕ 114mm/1.3m)
Dimension	: 336(H)×184(W)×172(L) mm (13.2(H)×7.2(W)×6.8(L) in)
Weight	
Instrument	
(with battery)	: 4.9kg (10.8 lbs)
(without battery)	: 4.6kg (10.1 lbs)
Plastic carrying case	: 3.4kg (7.5 lbs) (Weight of the carrying case may be slightly different due to specific market.)
Durability	
Protection against water and dust	: IP54(with BT-G1) (Based on the standard IEC60529)
Ambient Temperature Range	: -20°C to +50°C (-4°F to +122°F)

Battery BT-G1 (This battery does not contain mercury.)

Out put voltage	: 7.2 V
Capacity	: 2300mAh(Ni-MH)
Number of cells	: 6
Maximum operating time (when fully recharged) at +20°C (+68°F)	
Including distance measurement	: 9hours (10,000 points)
Angle measurement only	: 40hours
Weight	: 0.3kg (0.7 lbs)

Battery Charger BC-G1C

Input voltage	: AC 220V(BC-G1C)
Frequency	: 50Hz
Recharging time (at +20°C /+68°F) Battery BT-G1	: 1.8 hours
Discharging time (at +20°C /+68°F) Battery BT-G1	: 10 hours (in case of full charge)
Operating temperature	: +10°C to +40°C (+50°F to 104°F)
Charging signal	: Red lamp illumination
Refreshing signal	: Yellow lamp illumination
Finishing signal	: Green lamp illumination
Weight	: 0.5kg (1.1 lbs)

•Battery using time will vary depending on environmental conditions and operations done with FTS 300 series.

APPENDIX

1 Precaution when Charging or Storing Batteries

The capacity of battery will be affected and its service life shortened in any of the following cases while it is recharged, discharged or stored.

1) Recharging

Fig. 1 shows how ambient temperature at recharging is related to charging efficiency or as affecting discharge capacity. As seen from the figure, charging at normal temperature is best, and the efficiency decreases as the temperature rises. It is best, therefore, to always recharge the battery at normal temperature to obtain full use of battery capacity and enjoy maximum operation per charge. And the service life of your battery will be shortened if it is frequently overcharged or recharged at high temperature.

Note: 0.1C charge means that the battery is recharged with 0.1 -time current as against its capacity.

2) Discharge

Fig. 2 shows discharge temperature characteristics. Discharge characteristics at high temperature are the same as those at normal temperatures. The battery is likely to have reduced discharge capacity as well as lower discharged voltage when discharged at low temperature. And the service life of your battery will be shortened if it is greatly overcharged.

Note: 1C discharge means one with 1 -time current over battery capacity.

3) Storage

See Fig. 3 for how storing period at different temperature levels is related to the remaining capacity. The battery will lose its capacity as storage temperature rises and the storage period increases.

This does not mean, however, that the battery performance is damaged when the battery is stored. The battery, reduced in capacity, will be restored once it is recharged. Always recharge your battery before use. And recharge and discharge the battery 3 or 4 times to restore its capacity if it has been stored for a long period or at high temperature. Storing at high temperature can adversely affect the service life of your battery.

Your battery has been fully charged before leaving the factory, but its capacity may be affected considerably when it takes several months to reach you, if it is stored at high temperature area or passes through a high-temperature region. Then, the battery must be recharged and discharged 3~4 times to fully restore its capacity.

And the battery should always be stored at normal temperature or lower if it will not be used for any long period. This helps your battery have a longer service life.

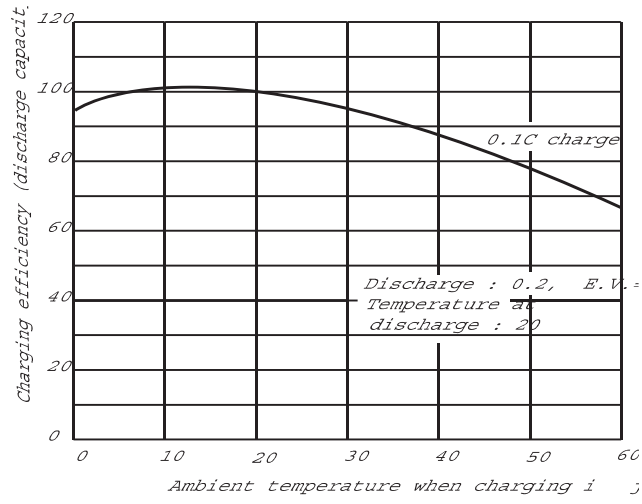

Fig.1 Recharging

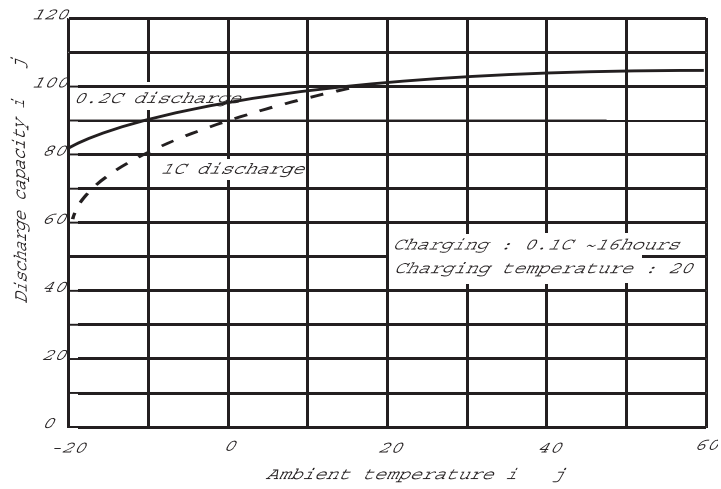

Fig. 2 Discharge

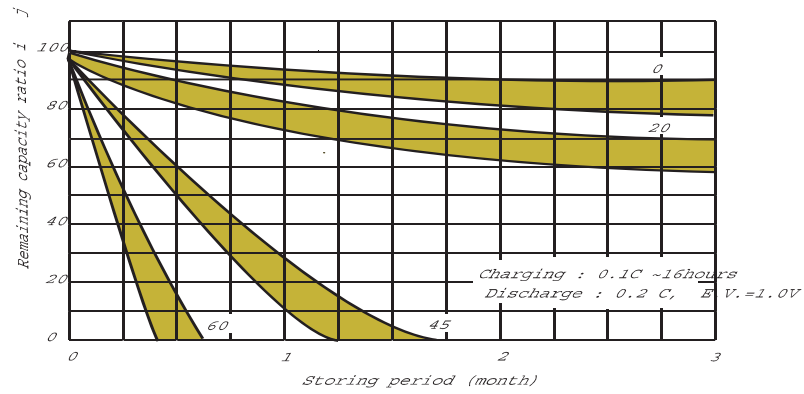

Fig. 3 Storage